

Commercial Solutions Catalog







2026



www.InabaDenko-America.com



TABLE OF CONTENTS

	SLIMDUCT RD METAL LINESET ENCLOSURE FOR VRF/VRV SYSTEMS 4
	SLIMDUCT PD COMMERCIAL LINESET COVER SYSTEM 18
	SUPERLOCK HORIZONTAL LINESET SUPPORT 24
	LINEBRACE VERTICAL LINESET SUPPORT 28
	TAPE 30
	PAIRCOIL INSULATED COPPER TUBE/PIPE 32
	DSH-UP THERMAL INSULATED DRAIN-UP HOSE KIT FOR INDOOR AC UNITS 34



[Click here for full product description](#)



[Check out our Youtube Playlist](#)

SLIMDUCT™ RD

Metal Lineset Enclosure for VRF/VRV Systems

The SLIMDUCT RD Commercial Lineset Cover is the aesthetically pleasing and cost-effective way to enclose and protect exposed rooftop lineset layouts, and the multiple linesets needed for VRV/VRF applications. Easy to install and field configurable to any orientation, SLIMDUCT RD is the labor-saving alternative to custom-fabricated lineset ducting options.

TECHNICAL SPECS

Material

Highly corrosion-resistant hot-dip galvanized steel sheet has a coating layer of zinc, 6% aluminum, and 3% magnesium.

Tensile Strength

More than 274.6N/mm²
(=28kgf/mm²) (=39.885psi)

Salt Tolerance

Salt Resistant

Stretch

More than 28%

Allowable load of base (duct base + strut)

Allowable load (allowable pipe weight) of base part for 37-3/8" - and 78-3/4" - RD ducts.

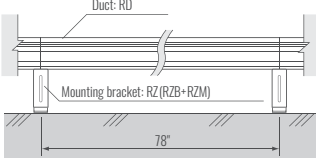
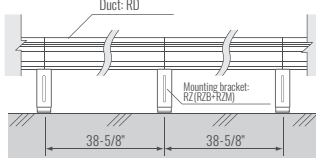
Item	Allowable load for 2-m RD duct	
	78-3/4" RD duct (pipe support by 3 strut)	78-3/4" RD duct x 2 (pipe support by 4 strut)
		
Duct size		
RD-150	9387N (958kgf) (2,110lbs)	12548N (1280kgf) (2,110lbs)
RD-300	3929N (401kgf) (883lbs)	05281N (439kgf) (1,187lbs)
RD-450	2546N (260kgf) (572lbs)	03448N (352kgf) (775lbs)
RD-600	1837N (187kgf) (413lbs)	02513N (256kgf) (565lbs)
RD-900	1102N (112kgf) (247lbs)	01552N (158kgf) (349lbs)
RD-450H	2494N (255kgf) (560lbs)	03396N (347kgf) (763lbs)
RD-600H	1785N (182kgf) (401lbs)	02461N (251kgf) (553lbs)
RD-900H	2231N (228kgf) (501lbs)	03076N (314kgf) (691lbs)

■ It is substantially the allowable load of the strut (in the assembled state).

Allowable load

This is the strength of cover (allowable load for cover being restored to the original state) when the cover is attached to the base (duct base + strut). Note that values for the W600 to H900 sizes and the walkway type are those in the state where the cover plate is attached.

Specifications	Strength of cover	
	for 1ft ²	When load is applied (7-7/8" x 4")
Standard type	4,903 N/m ² (500 kgf/m ²) (102.4 lbs/ft ²) or less	98N (10 kgf) (22.1 lbs/ft ²) or less
Walkway type	49,003 N/m ² (5,000 kgf/m ²) (1,024.0 lbs/ft ²) or less	980N (100 kgf) (221.0 lbs/ft ²) or less

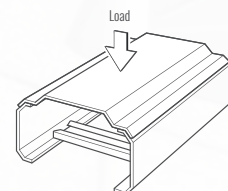

Item	Insulation thickness	Lineset size (Liquid line x Suction line)											
		1/4" x 3/8"	1/4" x 1/2"	1/4" x 5/8"	3/8" x 5/8"	3/8" x 3/4"	1/2" x 1-1/8"	5/8" x 1-1/8"	5/8" x 1-1/4"	3/4" x 1-1/4"	3/4" x 1-1/2"	7/8" x 1-1/2"	7/8" x 1-5/8"
RD-150	1/2" x 1/2"	3	2	2	2	2	1	1	1	1	1	1	1
	3/4" x 3/4"	1	1	1	1	1	1	1	1	1	0	0	0
RD-300	1/2" x 1/2"	6	6	5	5	4	2	2	2	2	2	2	2
	3/4" x 3/4"	2	2	2	2	2	2	2	2	2	2	1	1
RD-300H	1/2" x 1/2"	15	13	12	12	10	8	8	6	6	6	6	4
	3/4" x 3/4"	8	7	7	7	6	4	4	4	4	4	3	3
RD-450	1/2" x 1/2"	10	8	7	7	6	4	4	4	3	3	3	3
	3/4" x 3/4"	4	4	4	4	3	3	3	3	3	3	2	2
RD-450H	1/2" x 1/2"	23	20	18	18	15	12	11	10	10	8	8	6
	3/4" x 3/4"	13	11	10	10	9	6	6	6	6	6	5	5
RD-600	1/2" x 1/2"	13	12	10	10	9	5	5	5	5	4	4	4
	3/4" x 3/4"	5	5	5	5	5	4	4	4	4	4	3	3
RD-600H	1/2" x 1/2"	31	26	24	24	19	14	14	13	13	13	11	8
	3/4" x 3/4"	17	14	14	14	12	8	8	8	8	8	7	7
RD-900	1/2" x 1/2"	20	17	16	16	13	8	8	8	7	7	7	6
	3/4" x 3/4"	8	8	8	8	7	6	6	6	6	6	5	5
RD-900H	1/2" x 1/2"	46	40	37	36	30	24	21	20	20	14	14	13
	3/4" x 3/4"	26	22	22	21	18	13	13	13	12	11	11	11

■ Nominal lineset capacities for SLIMDUCT RD can differ according to the configurations of lineset installed. Capacities shown are based on Net Usable Section Area of each duct size and are for reference purpose only.

■ Attractive

SLIMDUCT RD encloses the multiple lines used by variable refrigerant flow/volume (VRF/VRV) multi-split systems. Requiring less space than traditional racking/jacketing system, its compact design delivers a clean, professional, and finished look to any rooftop project. It blends in perfectly with any type of commercial building.

■ Multiple Applications

A wide array of fittings, including risers, vertical mountings, and under-slab mountings, are readily available to easily customize while on the job site, during the installation process. SLIMDUCT RD can also be installed in any orientation.

■ Easy to Assemble

SLIMDUCT RD is engineered to make installation a time-saving process. No special tools are required to assemble and connect the interlocking covers together. The screws needed, are included with the product.

Click here
for
installation
instructions



■ Durability

Fabricated from sheets of high-grade, corrosion-resistant, and hot-dipped galvanized steel, SLIMDUCT RD is coated with zinc, aluminum, and magnesium. This scratch, abrasion and corrosion-resistant coating offers better protection than stainless steel, even in highly corrosive environments such as coastal areas.

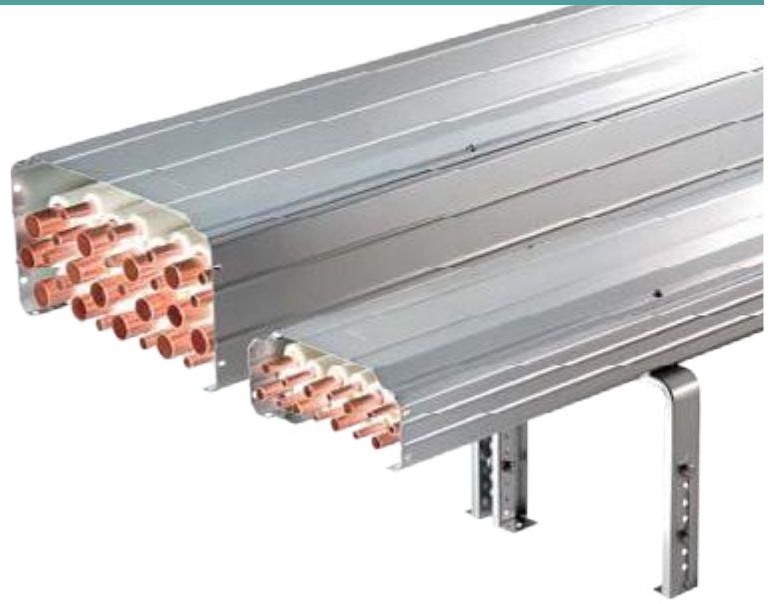

- Baseplate shown is an optional accessory for all sizes except RD-150-05, which includes the baseplate.

Dimensions

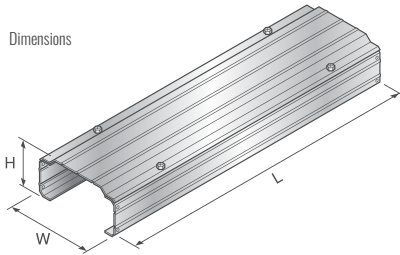

- RD150 size: Not possible to use without coupler.
- Use RFJ (free coupler) for RD connection if you cut RD duct.
- In vertical applications, for safety, do not connect without using coupler.
- For vertical applications, do not use brackets when mounting sizes 600 (H) and 900 (H) to wall. In vertical applications when mounted direct to the wall, size 900 (H) cannot be used with elbows. If duct needs to be raised from wall surface, use a baseplate RDB, REB, RFB, RTS, or RJB.
- Size 600 (H), 900 (H) are supplied with reinforced plate for cover. Size 450 (H) is not supplied with it, it is an optional accessory for size 450 (H).
- Size 600 (H), 900 (H) are supplied with reinforced plate for joint.
- For further information, refer to SLIMDUCT RD Installation Manual.

Code No.	Item No.	Length (L)	Width (W)	Height (H)
C 77017	RD-150-A-ZA	78-3/4"	6"	4-3/8"
C 77027	RD-150-1-A-ZA	39-3/8"		
C 77037	RD-150-05-A-ZA	19-3/4"		
C 85002	RD-300-D-ZA	78-3/4"	11-7/8"	5-3/8"
C 85092	RD-300-1-D-ZA	39-3/8"		
C 85182	RD-300-5-D-ZA	19-3/4"		
C 85272	RD-300-3-D-ZA	11-7/8"	11-7/8"	10"
C 85042	RD-300H-D-ZA	78-3/4"		
C 85132	RD-300H-1-D-ZA	39-3/8"		
C 85222	RD-300H-5-D-ZA	19-3/4"	17-3/4"	5-3/8"
C 85312	RD-300H-3-D-ZA	11-7/8"		
C 85012	RD-450-D-ZA	78-3/4"		
C 85102	RD-450-1-D-ZA	39-3/8"	17-3/4"	10"
C 85192	RD-450-5-D-ZA	19-3/4"		
C 85282	RD-450-3-D-ZA	11-7/8"		
C 85052	RD-450H-D-ZA	78-3/4"	23-5/8"	5-3/8"
C 85142	RD-450H-1-D-ZA	39-3/8"		
C 85232	RD-450H-5-D-ZA	19-3/4"		
C 85322	RD-450H-3-D-ZA	11-7/8"	23-5/8"	10"
C 85022	RD-600-D-ZA	78-3/4"		
C 85112	RD-600-1-D-ZA	39-3/8"		
C 85202	RD-600-5-D-ZA	19-3/4"	35-1/2"	5-3/8"
C 85292	RD-600-3-D-ZA	11-7/8"		
C 85062	RD-600H-D-ZA	78-3/4"		
C 85152	RD-600H-1-D-ZA	39-3/8"	35-1/2"	10"
C 85242	RD-600H-5-D-ZA	19-3/4"		
C 85332	RD-600H-3-D-ZA	11-7/8"		
C 85032	RD-900-D-ZA	78-3/4"	35-1/2"	5-3/8"
C 85122	RD-900-1-D-ZA	39-3/8"		
C 85212	RD-900-5-D-ZA	19-3/4"		
C 85302	RD-900-3-D-ZA	11-7/8"	35-1/2"	10"
C 85072	RD-900H-D-ZA	78-3/4"		
C 85162	RD-900H-1-D-ZA	39-3/8"		
C 85252	RD-900H-5-D-ZA	19-3/4"	35-1/2"	10"
C 85342	RD-900H-3-D-ZA	11-7/8"		



- Baseplate shown in the picture is an optional accessory.

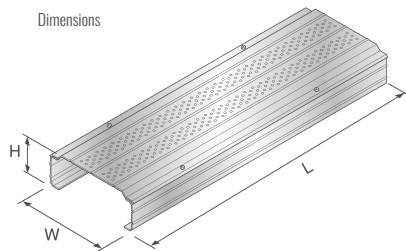

- Use RFJ (free coupler) for RD connection if you cut RD duct.
- Do not use for vertical applications.
- Size 450 (H), 600 (H), 900 (H) are supplied with reinforced plate for cover.
- Size 600 (H), 900 (H) are supplied with reinforced plate for joint.
- All sizes are supplied with reinforced wide plate for walkway.

Code No.	Item No.	Length (L)	Width (W)	Height (H)	Pcs/Pkg
C 88002	RDW-300-D-ZA	Special Order Only!	78-3/4"	11-7/8"	5-3/8"
C 88092	RDW-300-1-D-ZA	Special Order Only!	39-3/8"		
C 88182	RDW-300-5-D-ZA	Special Order Only!	19-3/4"		
C 88272	RDW-300-3-D-ZA	Special Order Only!	11-7/8"		
C 88042	RDW-300H-D-ZA	Special Order Only!	78-3/4"	11-7/8"	10"
C 88132	RDW-300H-1-D-ZA	Special Order Only!	39-3/8"		
C 88222	RDW-300H-5-D-ZA	Special Order Only!	19-3/4"		
C 88312	RDW-300H-3-D-ZA	Special Order Only!	11-7/8"		
C 88012	RDW-450-D-ZA	Special Order Only!	78-3/4"	17-3/4"	5-3/8"
C 88102	RDW-450-1-D-ZA	Special Order Only!	39-3/8"		
C 88192	RDW-450-5-D-ZA	Special Order Only!	19-3/4"		
C 88282	RDW-450-3-D-ZA	Special Order Only!	11-7/8"		
C 88052	RDW-450H-D-ZA	Special Order Only!	78-3/4"	17-3/4"	10"
C 88142	RDW-450H-1-D-ZA	Special Order Only!	39-3/8"		
C 88232	RDW-450H-5-D-ZA	Special Order Only!	19-3/4"		
C 88322	RDW-450H-3-D-ZA	Special Order Only!	11-7/8"		
C 88022	RDW-600-D-ZA	Special Order Only!	78-3/4"	23-5/8"	5-3/8"
C 88112	RDW-600-1-D-ZA	Special Order Only!	39-3/8"		
C 88202	RDW-600-5-D-ZA	Special Order Only!	19-3/4"		
C 88292	RDW-600-3-D-ZA	Special Order Only!	11-7/8"		
C 88062	RDW-600H-D-ZA	Special Order Only!	78-3/4"	23-5/8"	10"
C 88152	RDW-600H-1-D-ZA	Special Order Only!	39-3/8"		
C 88242	RDW-600H-5-D-ZA	Special Order Only!	19-3/4"		
C 88332	RDW-600H-3-D-ZA	Special Order Only!	11-7/8"		
C 88032	RDW-900-D-ZA	Special Order Only!	78-3/4"	35-1/2"	5-3/8"
C 88122	RDW-900-1-D-ZA	Special Order Only!	39-3/8"		
C 88212	RDW-900-5-D-ZA	Special Order Only!	19-3/4"		
C 88302	RDW-900-3-D-ZA	Special Order Only!	11-7/8"		
C 88072	RDW-900H-D-ZA	Special Order Only!	78-3/4"	35-1/2"	10"
C 88162	RDW-900H-1-D-ZA	Special Order Only!	39-3/8"		
C 88252	RDW-900H-5-D-ZA	Special Order Only!	19-3/4"		
C 88342	RDW-900H-3-D-ZA	Special Order Only!	11-7/8"		

RE

90° FLAT ELBOW

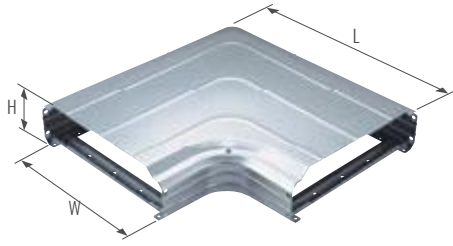

Code No.	Item No.	Width (W)	Height (H)	Length (L)	Pcs/Pkg
C 77125	RE-150-ZA	6"	4-3/8"	9-7/8"	1
C 85362	RE-300-D-ZA	11-7/8"	5-1/4"	19-3/4"	1
C 85372	RE-450-D-ZA	17-3/4"	5-1/4"	25-5/8"	1
C 85382	RE-600-D-ZA	23-5/8"	5-3/8"	31-1/2"	1
C 85392	RE-300H-D-ZA	11-7/8"	10"	19-3/4"	1
C 85402	RE-450H-D-ZA	17-3/4"	10"	25-5/8"	1
C 85412	RE-600H-D-ZA	23-5/8"	10"	31-1/2"	1

- Size 600 (H) is supplied with reinforced plate for cover. (It is an optional accessory for size 450H.)
- Size 600 (H) is supplied with reinforced plate for joint.
- Use RX-900 (H) as flat elbow for size 900 (H).

REW

90° FLAT ELBOW - WALKWAY

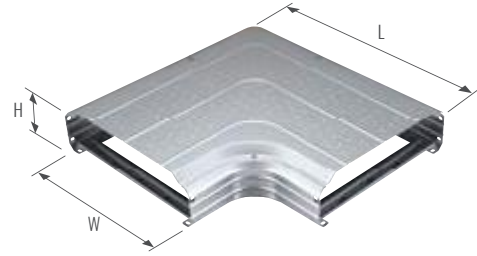

Code No.	Item No.	Width (W)	Height (H)	Length (L)	Pcs/Pkg	
C 88362	REW-300-D-ZA	Special Order Only!	11-7/8"	5-3/8"	19-3/4"	1
C 88372	REW-450-D-ZA	Special Order Only!	17-3/4"	5-3/8"	25-5/8"	1
C 88382	REW-600-D-ZA	Special Order Only!	23-5/8"	5-3/8"	31-1/2"	1
C 88392	REW-300H-D-ZA	Special Order Only!	11-7/8"	10"	19-3/4"	1
C 88402	REW-450H-D-ZA	Special Order Only!	17-3/4"	10"	25-5/8"	1
C 88412	REW-600H-D-ZA	Special Order Only!	23-5/8"	10"	31-1/2"	1

- Size 600 (H) is supplied with reinforced plate for joint.
- All sizes are supplied with reinforced wide plate for walkway.
- Use RXW-900 (H) as flat elbow for size 900 (H).

RF

45° FLAT ELBOW

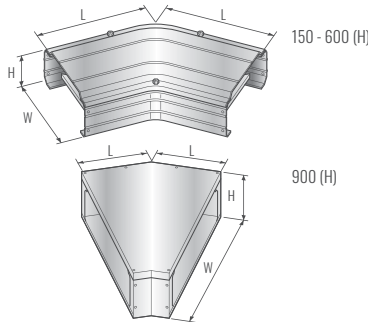

Code No.	Item No.	Width (W)	Height (H)	L	Pcs/Pkg	
C 77125	RF-150-ZA	6"	4-3/8"	4-3/8"	1	
C 85432	RF-300-D-ZA	11-7/8"	5-1/4"	12-7/8"	1	
C 85442	RF-450-D-ZA	17-3/8"	5-1/4"	15-1/2"	1	
C 85452	RF-600-D-ZA	23-5/8"	5-3/8"	18"	1	
C 89045	RF-900-A-ZA	Special Order Only!	38-5/8"	7-7/8"	22"	1
C 85462	RF-300H-D-ZA	11-7/8"	10"	12-7/8"	1	
C 85472	RF-450H-D-ZA	17-3/4"	10"	15-1/2"	1	
C 85482	RF-600H-D-ZA	23-5/8"	10"	18"	1	
C 85295	RF-900H-D-ZA	Special Order Only!	38-5/8"	12-5/8"	22"	1

- Size 600 (H) is supplied with reinforced plate for cover. (It is an optional accessory for size 450H.) Size 600 (H) is supplied with reinforced plate for joint. Height of stand for size 900 (H) is 11/4" lower than ducting.

RFW

45° FLAT ELBOW - WALKWAY

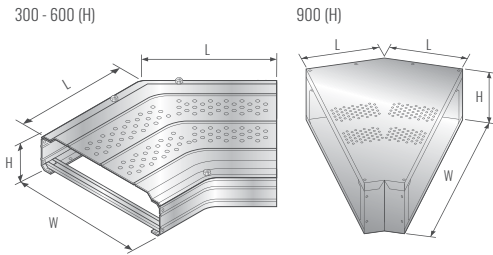

Code No.	Item No.	Width (W)	Height (H)	L	Pcs/Pkg	
C 88432	RFW-300-ZA	Special Order Only!	11-7/8"	5-3/8"	12-7/8"	1
C 88442	RFW-450-D-ZA	Special Order Only!	17-3/4"	5-3/8"	15-1/2"	1
C 88452	RFW-600-D-ZA	Special Order Only!	23-5/8"	5-3/8"	15-1/8"	1
C 88441	RFW-900-D-ZA	Special Order Only!	38-5/8"	7-7/8"	22"	1
C 88462	RFW-300H-D-ZA	Special Order Only!	11-7/8"	10"	19-3/4"	1
C 88472	RFW-450H-D-ZA	Special Order Only!	17-3/4"	10"	25-5/8"	1
C 88482	RFW-600H-D-ZA	Special Order Only!	23-5/8"	10"	31-1/2"	1
C 88841	RFW-900H-C-ZA	Special Order Only!	38-5/8"	12-5/8"	22"	1

- Size 600(H) is supplied with reinforced plate for joint. All sizes are supplied with reinforced wide plate for walkway. Height of stand for size 900 (H) is 11/4" lower than straight duct.

RFS

ADJUSTABLE ELBOW

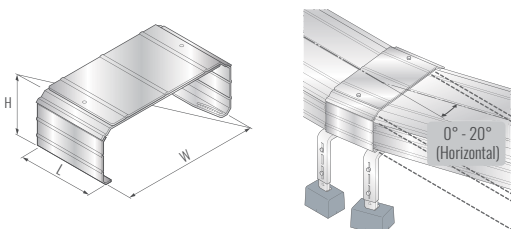

Code No.	Item No.	Width (W)	Height (H)	L	Pcs/Pkg	
C 81610	RFW-300-ZA	Special Order Only!	12"	5-1/2"	9-1/2"	1
C 81611	RFW-450-ZA	Special Order Only!	17-7/8"	5-1/2"	11-1/2"	1
C 81612	RFW-600-ZA	Special Order Only!	23-7/8"	5-1/2"	13-1/2"	1
C 81613	RFW-900-ZA	Special Order Only!	38-5/8"	5-1/2"	17-3/8"	1
C 81614	RFW-300H-ZA	Special Order Only!	12"	10-1/4"	9-1/2"	1
C 81615	RFW-450H-ZA	Special Order Only!	17-7/8"	10-1/4"	11-1/2"	1
C 81616	RFW-600H-ZA	Special Order Only!	23-7/8"	10-1/4"	13-1/2"	1
C 81617	RFW-900H-ZA	Special Order Only!	38-5/8"	10-1/4"	17-3/8"	1

RFSW

ADJUSTABLE ELBOW - WALKWAY

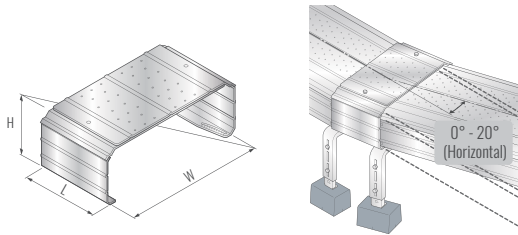

Code No.	Item No.	Width (W)	Height (H)	L	Pcs/Pkg	
C 81620	RFSW-300-ZA	Special Order Only!	12"	5-1/2"	9-1/2"	1
C 81621	RFSW-450-ZA	Special Order Only!	17-7/8"	5-1/2"	11-1/2"	1
C 81622	RFSW-600-ZA	Special Order Only!	23-7/8"	5-1/2"	13-1/2"	1
C 81623	RFSW-900-ZA	Special Order Only!	38-5/8"	5-1/2"	17-3/8"	1
C 81624	RFSW-300H-ZA	Special Order Only!	12"	10-1/4"	9-1/2"	1
C 81625	RFSW-450H-ZA	Special Order Only!	17-7/8"	10-1/4"	11-1/2"	1
C 81626	RFSW-600H-ZA	Special Order Only!	23-7/8"	10-1/4"	13-1/2"	1
C 81627	RFSW-900H-ZA	Special Order Only!	38-5/8"	10-1/4"	17-3/8"	1

RC

90° VERTICAL ELBOW <SIZE 150>

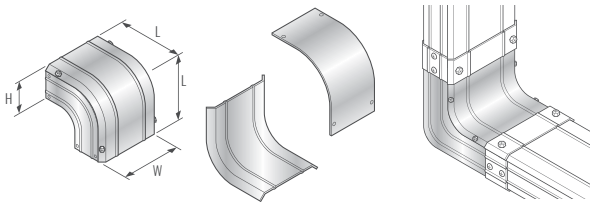

Code No.	Item No.	Width (W)	Height (H)	L	Pcs/Pkg
C 77135	RC-150-ZA	6"	4-3/8"	8-3/8"	1

■ Includes 2 extra parts which allows this fitting to be used as an inside vertical elbow or an outside vertical elbow.

RCI

90° INSIDE VERTICAL ELBOW

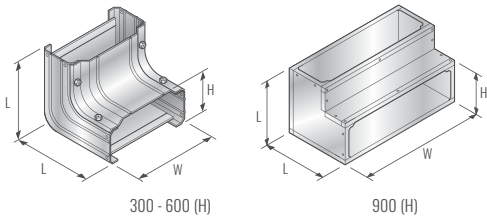

■ To connect between elbow fittings on size 900 (H), use RX1.

Code No.	Item No.	Width (W)	Height (H)	L	Pcs/Pkg	
C 85642	RCI-300-C-ZA		11-7/8"	11-7/8"	11-7/8"	1
C 85652	RCI-450-C-ZA		17-3/4"	17-3/4"	17-3/4"	1
C 85662	RCI-600-C-ZA		23-5/8"	23-5/8"	23-5/8"	1
C 89055	RCI-900-A-ZA	Special Order Only!	38-5/8"	38-5/8"	38-5/8"	1
C 85672	RCI-300H-C-ZA		17-7/8"	11-7/8"	11-7/8"	1
C 85682	RCI-450H-C-ZA		17-3/4"	17-3/4"	17-3/4"	1
C 85692	RCI-600H-C-ZA		23-5/8"	23-5/8"	23-5/8"	1
C 89305	RCI-900H-A-ZA	Special Order Only!	38-5/8"	38-5/8"	38-5/8"	1

RCO

90° OUTSIDE VERTICAL ELBOW

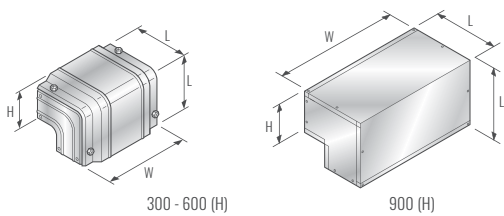

■ To connect between elbow fittings on size 900 (H), use RX1.

Code No.	Item No.	Width (W)	Height (H)	L	Pcs/Pkg	
C 85712	RCO-300-C-ZA		11-7/8"	11-7/8"	11-7/8"	1
C 85722	RCO-450-C-ZA		17-3/4"	17-3/4"	11-7/8"	1
C 85732	RCO-600-C-ZA		23-5/8"	23-5/8"	11-7/8"	1
C 89065	RCO-900-A-ZA	Special Order Only!	38-5/8"	38-5/8"	15"	1
C 85742	RCO-300H-C-ZA		11-7/8"	11-7/8"	15-7/8"	1
C 85752	RCO-450H-C-ZA		17-3/4"	17-3/4"	15-7/8"	1
C 85762	RCO-600H-C-ZA		23-5/8"	23-5/8"	15-7/8"	1
C 89315	RCO-900H-A-ZA	Special Order Only!	38-5/8"	38-5/8"	19-5/8"	1

RCF

45° VERTICAL ELBOW

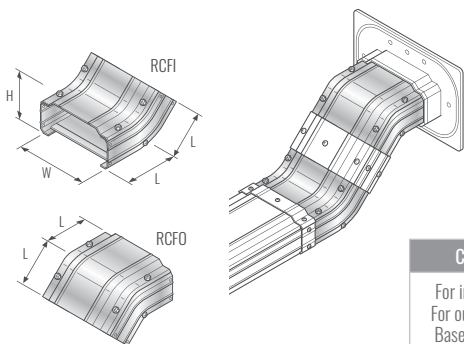

Contents
 For inside x 1pc.
 For outside x 1pc.
 Baseplate x 1pc.
 *Except 900 (H)

Code No.	Item No.	Part No.	Width (W)	Height (H)	L	Pcs/Pkg
C 77145	RCF-150-ZA	-	6"	4-3/8"	4-3/8"	1 set
C 85782	RCF-300-C-ZA	-	11-7/8"	5-1/4"	5-7/8"	1 set
C 85792	RCF-450-C-ZA	-	17-3/4"	5-1/4"	5-7/8"	1 set
C 85802	RCF-600-C-ZA	-	23-5/8"	5-3/8"	5-7/8"	1 set
C 85812	RCO-900-C-ZA	-	35-1/2"	5-3/8"	7-7/8"	1 set
C 85822	RCF-300H-C-ZA	-	17-7/8"	10"	7-7/8"	1 set
C 85842	RCF-450H-C-ZA	-	17-3/4"	10"	7-7/8"	1 set
C 85852	RCF-600H-C-ZA	-	23-5/8"	10"	7-7/8"	1 set
C 85862	RCO-900H-C-ZA	RCFI-900H-C-ZA	35-1/2"	10"	7-7/8"	1 set
C 85872	Special Order Only!	RCFO-900H-C-ZA			8-1/4"	1 set

RSS

ADJUSTABLE COUPLER

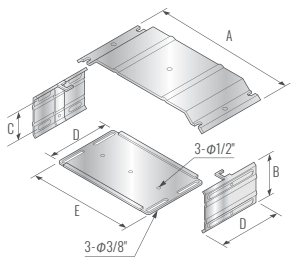

Layout

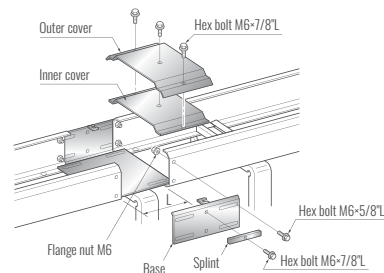
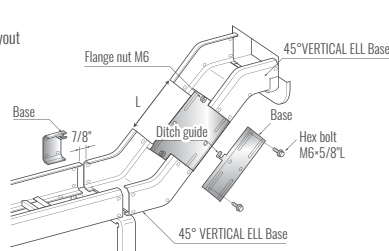

Code No.	Item No.	A	B	C	D	E	L	Pcs/Pkg
C 85637	RSS-300-1-A-ZA	11-3/4"	4-1/4"	2-3/8"	6-3/8"	10-1/2"	7/8" - 4-3/4"	1
C 85647	RSS-300-2-A-ZA				10-1/4"		4-3/4" - 8-3/4"	1
C 85657	RSS-300-3-A-ZA				14-1/4"		8-3/4" - 12-5/8"	1
C 85667	RSS-450-1-A-ZA	17-5/8"			6-3/8"	16-1/2"	7/8" - 4-3/4"	1
C 85677	RSS-450-2-A-ZA				10-1/4"		4-3/4" - 8-3/4"	1
C 85687	RSS-450-3-A-ZA				14-1/4"		8-3/4" - 12-5/8"	1
C 85697	RSS-600-1-A-ZA	23-5/8"	6-3/8"	22-3/8"	7/8" - 4-3/4"	1		
C 85707	RSS-600-2-A-ZA		10-1/4"		4-3/4" - 8-3/4"	1		
C 85717	RSS-600-3-A-ZA		14-1/4"		8-3/4" - 12-5/8"	1		
C 84937	RSS-900-1-A-ZA	34-1/8"	6-3/8"	34-1/8"	7/8" - 4-3/4"	1		
C 84947	RSS-900-2-A-ZA		10-1/4"		4-3/4" - 8-3/4"	1		
C 84957	RSS-900-3-A-ZA		14-1/4"		8-3/4" - 12-5/8"	1		

Code No.	Item No.	A	B	C	D	E	L	Pcs/Pkg
C 84597	RSS-300H-1-A-ZA	11-3/4"	8-7/8"	5-5/8"	6-3/8"	10-1/2"	7/8" - 4-3/4"	1
C 84607	RSS-300H-2-A-ZA				10-1/4"		4-3/4" - 8-3/4"	1
C 84617	RSS-300H-3-A-ZA				14-1/4"		8-3/4" - 12-5/8"	1
C 85727	RSS-450H-1-A-ZA	17-5/8"			6-3/8"	16-1/2"	7/8" - 4-3/4"	1
C 85737	RSS-450H-2-A-ZA				10-1/4"		4-3/4" - 8-3/4"	1
C 85747	RSS-450H-3-A-ZA				14-1/4"		8-3/4" - 12-5/8"	1
C 85757	RSS-600H-1-A-ZA	23-5/8"	6-3/8"	22-3/8"	7/8" - 4-3/4"	1		
C 85767	RSS-600H-2-A-ZA		10-1/4"		4-3/4" - 8-3/4"	1		
C 85777	RSS-600H-3-A-ZA		14-1/4"		8-3/4" - 12-5/8"	1		
C 84967	RSS-900H-1-A-ZA	35-3/8"	6-3/8"	34-1/8"	7/8" - 4-3/4"	1		
C 84977	RSS-900H-2-A-ZA		10-1/4"		4-3/4" - 8-3/4"	1		
C 84987	RSS-900H-3-A-ZA		14-1/4"		8-3/4" - 12-5/8"	1		

- RSS cannot be connected directly into a WALKWAY elbow unless it is extended to its maximum length and is attached using the outer edges of the slotted fixing holes along its side and bottom.
- ADJUSTABLE COUPLER - WALKWAY (RSSW) is a non-standard item, only available at special order.
- When connecting RSS to 78-3/4" or 39-3/8" length of RD duct or to 45° VERTICAL ELBOW (RCF), the baseplate cannot be installed. If you need to install the baseplate, please install in your responsibility.

RT

TEE

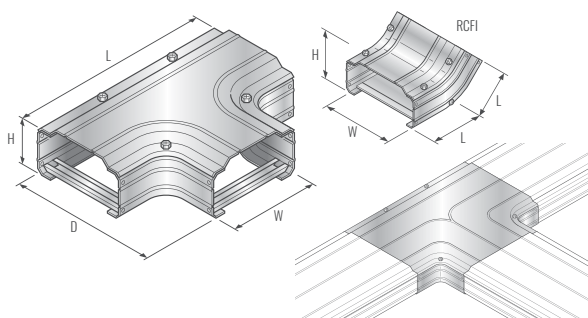

Code No.	Item No.	Width (W)	Height (H)	D	L	Pcs/Pkg
C 77115	RT-150-ZA	6"	4-3/4"	9-7/8"	13-7/8"	1
C 85502	RT-300-D-ZA	11-7/8"	5-1/4"	19-5/8"	27-5/8"	1
C 85512	RT-450-D-ZA	17-3/4"	5-1/4"	25-1/2"	33-1/2"	1
C 85522	RT-600-D-ZA	23-5/8"	5-3/8"	31-1/2"	39-3/8"	1
C 85532	RT-300H-D-ZA	11-7/8"	10"	19-3/4"	27-5/8"	1
C 88542	RT-450H-D-ZA	17-3/4"	10"	25-3/8"	33-1/2"	1
C 88552	RT-600H-D-ZA	23-5/8"	10"	31-1/2"	39-3/8"	1

- Size 600 (H) is supplied with reinforced plate for joint.
- Use RX-900 (H) for size 900 (H).

RTW

TEE - WALKWAY

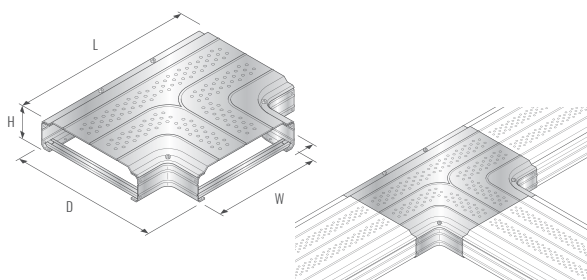

Code No.	Item No.	Width (W)	Height (H)	D	L	Pcs/Pkg	
C 88502	RTW-300-D-ZA	Special Order Only!	11-7/8"	5-3/8"	19-3/4"	27-5/8"	1
C 88512	RTW-450-D-ZA	Special Order Only!	17-3/4"	5-3/8"	25-5/8"	33-1/2"	1
C 88522	RTW-600-D-ZA	Special Order Only!	23-5/8"	5-3/8"	31-1/2"	39-3/8"	1
C 85532	RTW-300H-D-ZA	Special Order Only!	11-7/8"	10"	19-3/4"	27-5/8"	1
C 88542	RTW-450H-D-ZA	Special Order Only!	17-3/4"	10"	25-5/8"	33-1/2"	1
C 88552	RTW-600H-D-ZA	Special Order Only!	23-5/8"	10"	31-1/2"	39-3/8"	1

- Size 600 (H) is supplied with reinforced plate for joint.
- All sizes are supplied with reinforced wide plate for walkway.
- Use RXW-900 (H) for size 900 (H).

RXN

CROSS COUPLER

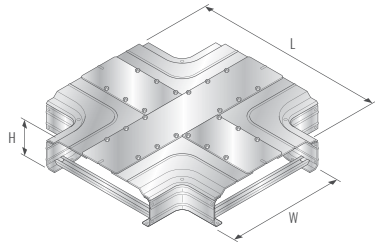

Code No.	Item No.	Width (W)	Height (H)	L	Pcs/Pkg
C 85572	RXN-300-D-ZA	11-7/8"	5-1/4"	27-5/8"	1
C 85582	RXN-450-D-ZA	17-3/4"	5-1/4"	33-1/2"	1
C 85592	RXN-600-D-ZA	23-5/8"	5-3/8"	39-3/8"	1
C 85602	RXN-300H-D-ZA	11-7/8"	10"	27-5/8"	1
C 85612	RXN-450H-D-ZA	17-3/4"	10"	33-1/2"	1
C 85622	RXN-600H-D-ZA	23-5/8"	10"	39-3/8"	1

RXNW

CROSS COUPLER - WALKWAY

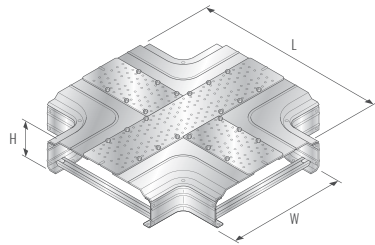

Code No.	Item No.	Width (W)	Height (H)	L	Pcs/Pkg	
C 85572	RXNW-300-D-ZA	Special Order Only!	11-7/8"	5-3/8"	27-5/8"	1
C 88582	RXNW-450-D-ZA	Special Order Only!	17-3/4"	5-3/8"	33-1/2"	1
C 88592	RXNW-600-D-ZA	Special Order Only!	23-5/8"	5-3/8"	39-3/8"	1
C 88602	RXNW-300H-D-ZA	Special Order Only!	11-7/8"	10"	27-5/8"	1
C 88612	RXNW-450H-D-ZA	Special Order Only!	17-3/4"	10"	33-1/2"	1
C 88622	RXNW-600H-D-ZA	Special Order Only!	23-5/8"	10"	39-3/8"	1

RSJ

COUPLER - For standard length duct & fittings

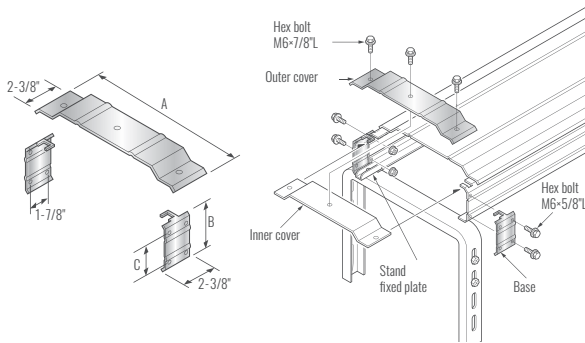

Code No.	Item No.	Width (W)	Height (H)	L	Pcs/Pkg	
C 77167	RSJ-150-A-ZA	6-1/8"	4-1/4"	-	15	
C 85537	RSJ-300-A-ZA	11-5/8"	4-1/4"	2-3/8"	15	
C 85547	RSJ-450-A-ZA	17-5/8"	4-1/4"	2-3/8"	15	
C 85557	RSJ-600-A-ZA	23-1/2"	4-1/4"	2-3/8"	9	
C 84917*	RSJ-900-A-ZA	Special Order Only!	35-1/4"	4-1/4"	2-3/8"	1
C 84557	RSJ-300H-A-ZA	11-5/8"	8-7/8"	8-7/8"	9	
C 85567	RSJ-450H-A-ZA	17-5/8"	8-7/8"	8-7/8"	9	
C 85577	RSJ-600H-A-ZA	22-3/4"	8-7/8"	8-7/8"	9	
C 84927*	RSJ-900H-A-ZA	Special Order Only!	35-1/4"	8-7/8"	8-7/8"	1

■ *To attach 900(H) elbows, use RXJ coupler.

RFJ

FREE COUPLER (A TYPE) - For cut part of duct (Mounted on the wall in vertical installation)

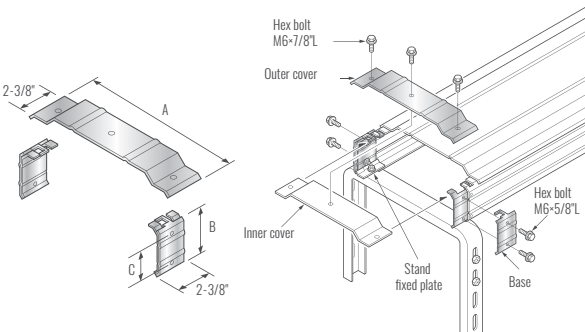

Code No.	Item No.	Width (W)	Height (H)	L	Pcs/Pkg	
C 77177	RFJ-150-A-ZA	6-1/8"	4-1/4"	-	15	
C 85587	RFJ-300-A-ZA	11-5/8"	4-1/4"	2-3/8"	15	
C 85597	RFJ-450-A-ZA	17-5/8"	4-1/4"	2-3/8"	15	
C 85607	RFJ-600-A-ZA	23-1/2"	4-1/4"	2-3/8"	9	
C 84877*	RFJ-900-A-ZA	Special Order Only!	35-1/4"	4-1/4"	2-3/8"	1
C 84567	RFJ-300H-A-ZA	11-5/8"	8-7/8"	8-7/8"	9	
C 85617	RFJ-450H-A-ZA	17-5/8"	8-7/8"	8-7/8"	9	
C 85627	RFJ-600H-A-ZA	23-1/2"	8-7/8"	8-7/8"	9	
C 84887*	RFJ-900H-A-ZA	Special Order Only!	35-1/4"	8-7/8"	8-7/8"	1

■ *To attach 900(H) elbows, use RXJ coupler.

RFJ

FREE COUPLER (S/H TYPE) - For cut part of duct (Mounted on the wall in vertical installation)

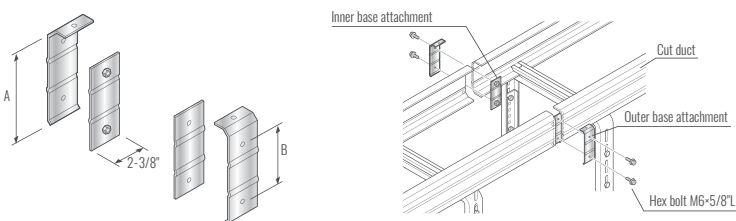

Code No.	Item No.	A	B	Pcs/Pkg
C 85901	RFJ-S-ZA	3-1/4"	1-1/4"	1
C 85911	RFJ-H-ZA	8"	3"	1

RR

REDUCER

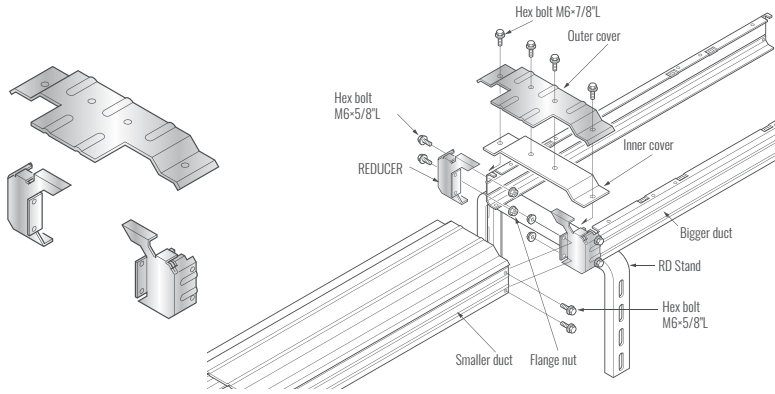

■ Baseplate is not available for REDUCER. For applications on vertical wall, do not use brackets to mount RR Reducer. If you need to install, please make and install the baseplate in advance in your responsibility.

Code No.	Item No.	Pcs/Pkg
C 85437	RR-300-150-A-ZA	1
C 85447	RR-450-300-A-ZA	1
C 85457	RR-600-300-A-ZA	1
C 85467	RR-600-450-A-ZA	1
C 84897	RR-900-600-A-ZA	Special Order Only!
C 84547	RR-300H-300-A-ZA	1
C 88957	RR-450H-300H-A-ZA	1
C 85487	RR-450H-450-A-ZA	1
C 88967	RR-600H-300H-A-ZA	1
C 85507	RR-600H-450-A-ZA	1
C 85527	RR-600H-600-A-ZA	1
C 85517	RR-600H-450H-A-ZA	1
C 84907	RR-900H-600H-A-ZA	Special Order Only!

RWP

WALL FLANGE

Size 150

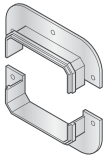

Assembly Drawing

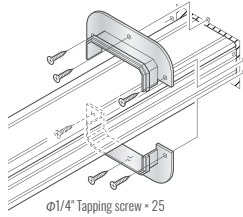

Dimensions

Size 150

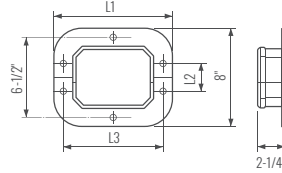

Size 300(H), 450(H), 600(H), 900(H)

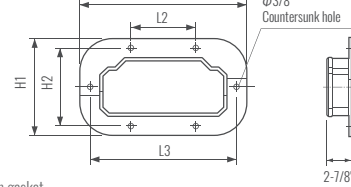

■ Contact surfaces on neck and flange include a factory fitted polyethylene foam gasket.

Size 300(H), 450(H), 600(H), 900(H)

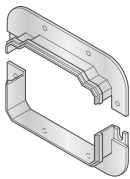

Assembly Drawing

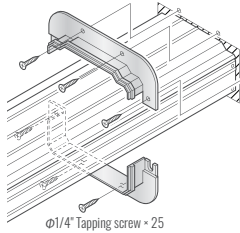

Code No.	Item No.	L1	L2	L3	H1	H2	Pcs/Pkg
C 77185	RWP-150-ZA	9-5/8"	2-1/4"	8-1/8"	-	-	1
C 75115	RWP-300-ZA	16-3/8"	6-3/8"	14-3/8"	9-5/8"	7-5/8"	1
C 75165	RWP-450-ZA	22-1/4"	12-1/4"	20-1/4"	9-5/8"	7-5/8"	1
C 79205	RWP-600-ZA	28-1/8"	15-3/4"	26-1/4"	9-5/8"	7-5/8"	1
C 89186	RWP-900-A-ZA	Special Order Only!	40"	25-5/8"	38"	9-5/8"	7-5/8"
C 84675	RWP-300H-ZA	16-3/8"	6-3/8"	14-3/8"	14-3/8"	12-3/8"	1
C 76865	RWP-450H-ZA	22-1/4"	12-1/4"	20-1/4"	14-3/8"	12-3/8"	1
C 79355	RWP-600H-ZA	28-1/8"	15-3/4"	26-1/4"	14-3/8"	12-3/8"	1
C 89466	RWP-900H-A-ZA	Special Order Only!	40"	25-5/8"	38"	14-3/8"	12-3/8"

RSB

WALL SLEEVE - Use in combination with RWP

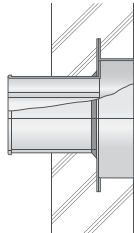
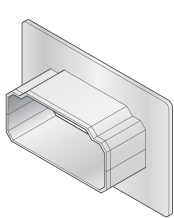

Dimensions

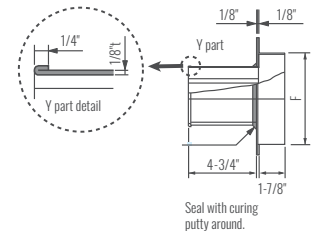
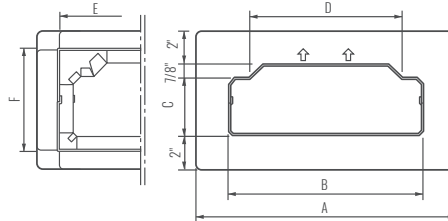

■ Use CHAMBER BOX (CB) for size 900 (H).

Code No.	Item No.	A	B	C	D	E	F	Pcs/Pkg
C 85835	RSB-300-ZA	15-1/2"	11-1/2"	3-1/2"	9"	13-1/8"	5-7/8"	1
C 85845	RSB-450-ZA	21-3/8"	17-3/8"	3-1/2"	15"	19"	5-7/8"	1
C 85855	RSB-600-ZA	27-1/4"	23-3/8"	3-1/2"	20-7/8"	24-7/8"	5-7/8"	1
C 84635	RSB-300H-ZA	15-1/2"	11-1/2"	8-1/4"	9"	13-1/8"	10-5/8"	1
C 85865	RSB-450H-ZA	21-3/8"	17-3/8"	8-1/4"	15"	19"	10-5/8"	1
C 85875	RSB-600H-ZA	27-1/4"	23-3/8"	8-1/4"	20-7/8"	24-7/8"	10-5/8"	1

Bracket Selector Table: 300(H), 450(H), 600(H), 900(H)

- To select the combination of bracket and riser which gives the required height, refer to the right table.
- If several combinations of bracket and riser give the desired height, the combination found in the column closest to the height will give the most practical selection.
- The combination of S Type RZB Risers and S Type RZM Brackets are only used for vertical wall mounted applications.

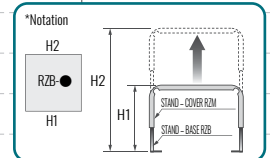
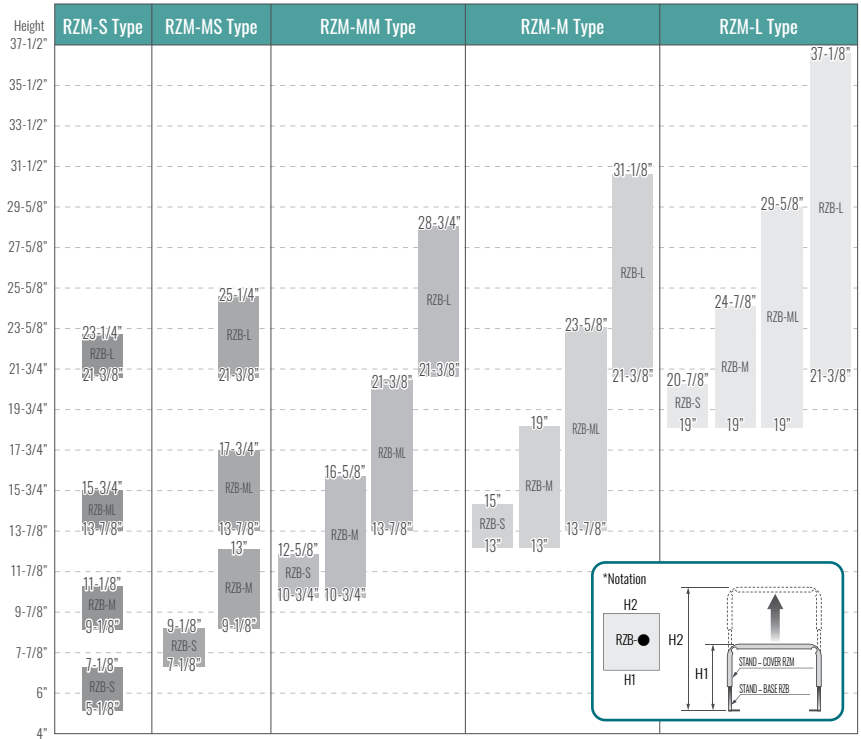

RZB RISER for RZM BRACKET - Use in combination with RZM

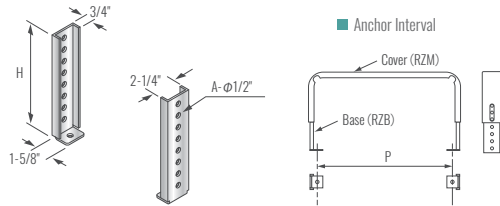

Type	P
300	12-1/8"
450	18"
600	24-3/4"
900	36-1/2"

Type	Code No.	Item No.	A	H	Pcs/Pkg
S	C 73695	RZB-S-A-ZA	1/4"	4"	20 set
M	C 73705	RZB-M-A-ZA	3/8"	7-7/8"	20 set
ML	C 73815	RZB-ML-A-ZA	1/2"	12-5/8"	10 set
L	C 73715	RZB-L-A-ZA	7/8"	20-1/8"	10 set

RZM BRACKET for RD DUCT - Use in combination with RZB

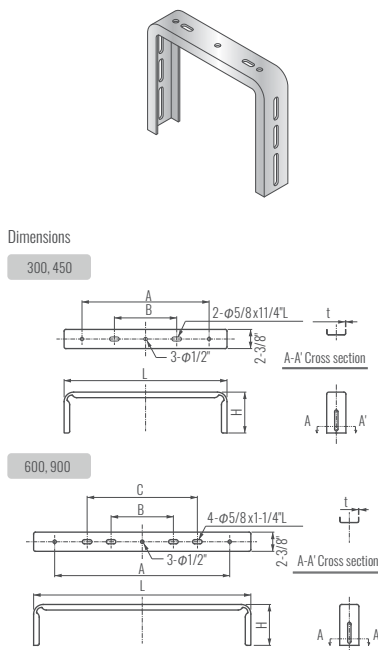

Type	Code No.	Item No.	A	B	C	H	L	I	Pcs/Pkg
S	C 73535	RZM-300-S-A-ZA	9-7/8"	7-3/4"	-	5-1/8"	14-1/4"	1/8"	2
	C 73545	RZM-450-S-A-ZA	15-3/4"	7-3/4"	-	5-1/8"	20-1/8"	1/8"	2
	C 73555	RZM-600-S-A-ZA	21-3/4"	7-3/4"	13-5/8"	5-1/8"	26-7/8"	1/8"	2
	C 73565	RZM-900-S-A-ZA	Special Order Only!	33-1/2"	13-5/8"	23-5/8"	5-1/8"	38-5/8"	1/8"
MS	C 73575	RZM-300-MS-A-ZA	9-7/8"	7-3/4"	-	7-1/8"	14-1/4"	1/8"	2
	C 73585	RZM-450-MS-A-ZA	15-3/4"	7-3/4"	-	7-1/8"	20-1/8"	1/8"	2
	C 73595	RZM-600-MS-A-ZA	21-3/4"	7-3/4"	13-5/8"	7-1/8"	26-7/8"	1/8"	2
	C 73605	RZM-900-MS-A-ZA	Special Order Only!	33-1/2"	13-5/8"	23-5/8"	7-1/8"	38-5/8"	1/8"
MM	C 73825	RZM-300-MM-A-ZA	9-7/8"	7-3/4"	-	10-3/4"	14-1/4"	1/8"	2
	C 73835	RZM-450-MM-A-ZA	15-3/4"	7-3/4"	-	10-3/4"	20-1/8"	1/8"	2
	C 73845	RZM-600-MM-A-ZA	21-3/4"	7-3/4"	13-5/8"	10-3/4"	26-7/8"	1/8"	2
	C 73855	RZM-900-MM-A-ZA	Special Order Only!	33-1/2"	13-5/8"	23-5/8"	10-3/4"	38-5/8"	1/8"
M	C 73615	RZM-300-M-A-ZA	9-7/8"	7-3/4"	-	13"	14-1/4"	1/8"	2
	C 73625	RZM-450-M-A-ZA	15-3/4"	7-3/4"	-	13"	20-1/8"	1/8"	2
	C 73635	RZM-600-M-A-ZA	21-3/4"	7-3/4"	13-5/8"	13"	26-7/8"	1/8"	2
	C 73645	RZM-900-M-A-ZA	Special Order Only!	33-1/2"	13-5/8"	23-5/8"	13"	38-5/8"	1/8"
L	C 73655	RZM-300-L-A-ZA	9-7/8"	7-3/4"	-	18-7/8"	14-1/4"	1/8"	2
	C 73665	RZM-450-L-A-ZA	15-3/4"	7-3/4"	-	18-7/8"	20-1/8"	1/8"	2
	C 73675	RZM-600-L-A-ZA	21-3/4"	7-3/4"	13-5/8"	18-7/8"	26-7/8"	1/8"	2
	C 73685	RZM-900-L-A-ZA	Special Order Only!	33-1/2"	13-5/8"	23-5/8"	18-7/8"	38-5/8"	1/8"

RZ-150

SINGLE BRACKET for Horizontal Installation (SIZE 150) - Not for vertical installation

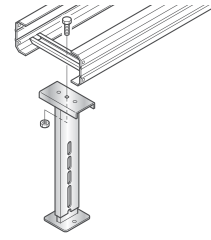
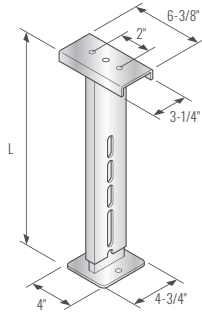

Code No.	Item No.	L	Pcs/Pkg
C 86135	RZ-150-M-ZA	11-1/8" - 19"	2
C 86175	RZ-150-L-ZA	19" - 28"	2
C 86215	RZ-150-LL-ZA	28" - 37-1/8"	2

REC

END CAP

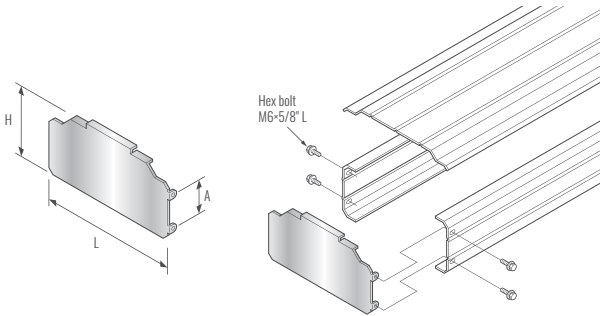

Code No.	Item No.	L	H	A	Pcs/Pkg	
C 77215	REC-150-ZA	6"	4-3/8"	2-3/8"	1	
C 85975	REC-300-ZA	11-3/4"	5"	2-3/8"	1	
C 85985	REC-450-ZA	17-5/8"	5"	2-3/8"	1	
C 85995	REC-600-ZA	23-1/2"	5"	2-3/8"	1	
C 88335	REC-900-ZA	Special Order Only!	35-3/8"	5"	2-3/8"	1
C 84645	REC-300H-ZA	11-3/4"	9-3/4"	5-3/8"	1	
C 86005	REC-450H-ZA	17-5/8"	9-3/4"	5-3/8"	1	
C 86015	REC-600H-ZA	23-1/2"	9-3/4"	5-3/8"	1	
C 88345	REC-900H-ZA	Special Order Only!	35-3/8"	9-3/4"	5-3/8"	1

RZC

BRACKET ATTACHMENT PLATE for VERTICAL ELBOW

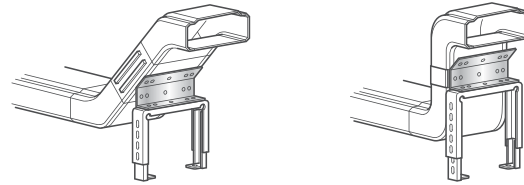
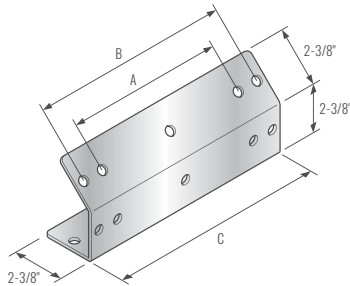

Code No.	Item No.	A	B	C	Pcs/Pkg	
C 86285	RZC-300-ZA	7-3/4"	9-7/8"	10-5/8"	1	
C 86295	RZC-450-ZA	7-3/4"	15-3/4"	16-1/2"	1	
C 86305	RZC-600-ZA	13-5/8"	21-5/8"	22-3/8"	1	
C 89685	RZC-900-ZA	Special Order Only!	23-5/8"	33-1/2"	35-1/2"	1

RDK

LINESET SUPPORT STRUT

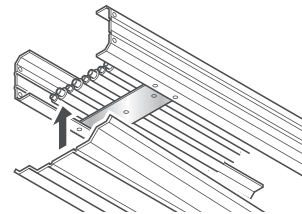
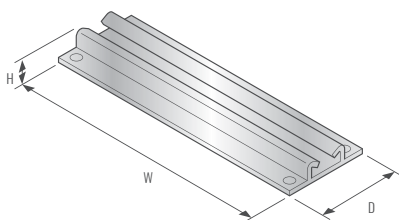

Code No.	Item No.	Compliant duct size	W	D	H	Pcs/Pkg
C 74865	RDK-300-ZA	300 (H)	10-1/2"	3-1/4"	5/8"	2
C 74885	RDK-450-ZA	450 (H)	16-1/2"	3-1/4"	5/8"	2
C 74845	RDK-600-ZA	600 (H)	22-3/8"	3-1/4"	5/8"	1





SLIMDUCT™ PD

Elevate lineset protection and installation appearance

Our SLIMDUCT PD Commercial Lineset Cover System is the durable and attractive solution to protect any surface-mounted lineset installation on commercial rooftop buildings. It also offers the added versatility to be used for HVAC and plumbing installations, or as a lineset cover between the condenser and SLIMDUCT RD System.

Using less space than a conventional racking system, its compact design optimizes limited space, while simplifying routine maintenance. Available in three different sizes to accommodate larger linesets, SLIMDUCT PD is constructed from a high-grade PVC that is weather resistant, UV stabilized and fire retardant. Easy to install, SLIMDUCT PD elevates linesets from the wall, ceiling, or deck surface.



[Click here for full product description](#)



[Check out our Youtube Playlist](#)

TECHNICAL SPECS

■ Weather Resistance

Tested to over 2,000 hours
(JIS D 0205, SWOM TEST)

■ Temperature Range

-4°F to 140 °F

■ Lineset Capacity

■ Size

Available in three sizes, 3-1/2", 4-5/8", 5-3/8", and three lengths, 37-7/8", 57-1/2", 78-3/4"

■ Mounting Hardware

Stainless steel mounting clip included for PDL, PDH, PDY and PDU

Item No.	Insulation thickness	Lineset size (Liquid line x Suction line)												
		1/4" x 3/8"	1/4" x 1/2"	1/4" x 5/8"	3/8" x 5/8"	3/8" x 3/4"	3/8" x 7/8"	1/2" x 1-1/8"	5/8" x 1-1/8"	5/8" x 1-1/4"	3/4" x 1-1/4"	3/4" x 1-1/2"	7/8" x 1-1/2"	7/8" x 1-5/8"
PD-90	1/2" x 1/2"	1	1	1	1	1	1	-	-	-	-	-	-	-
	3/4" x 3/4"	-	-	-	-	-	-	-	-	-	-	-	-	-
PD-120	1/2" x 1/2"	2	2	2	2	1	1	1	1	1	1	1	1	-
	3/4" x 3/4"	1	1	1	1	1	1	-	-	-	-	-	-	-
PD-140	1/2" x 1/2"	4	3	3	3	3	2	2	2	1	1	1	1	1
	3/4" x 3/4"	2	2	1	1	1	1	1	1	1	1	1	-	-

■ Includes Drain Hose(s) (O.D. 1-1/4")

SPECIAL FEATURES

■ Architectural Linesets Cover

Protects any surface mounted linesets installation, as well as linesets between condenser and SLIMDUCT RD system.

■ Innovative Design

Provides easy mounting and elevates linesets from wall, ceiling or deck surface.

■ Easy

All straight ducts and fittings disassemble for ease of installation, and mount with standard wall mounted pipe brackets.

■ Color

Available in Ivory to fit into various kinds of properties.

■ Fittings

A full range of fittings enables to accommodate any complicated configuration.



■ Versatile

HVAC and plumbing applications.



PD

STRAIGHT DUCT

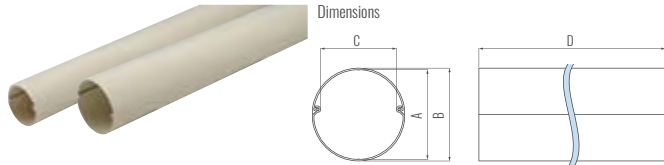

Code No.	Item No.	A	B (O.D.)	C (I.D.)	D	Pcs/Pkg
C 68302	PD-90-1000-I	3-1/2"	3-1/2"	3"	37-7/8"	5
C 68312	PD-90-1500-I	3-1/2"	3-1/2"	3"	57-1/2"	5
C 68322	PD-90-2000-I	3-1/2"	3-1/2"	3"	78-3/4"	5
C 68332	PD-120-1000-I	4-5/8"	4-5/8"	4-1/8"	37-7/8"	5
C 68342	PD-120-1500-I	4-5/8"	4-5/8"	4-1/8"	57-1/2"	5
C 68352	PD-120-2000-I	4-5/8"	4-5/8"	4-1/8"	78-3/4"	5
C 68632	PD-140-2000-I	5-3/8"	5-3/8"	5"	78-3/4"	5

PDBK

MOUNTING COUPLER FOR BRACKET

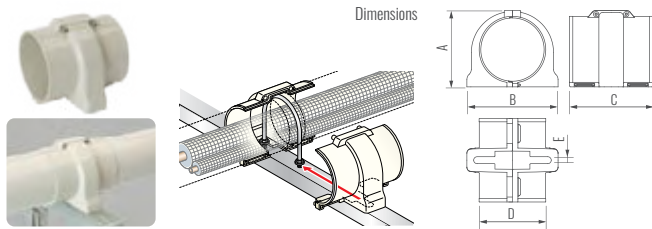

Code No.	Item No.	Inserting depth of duct	Applicable PD duct	Applicable U shape clamp or band (width 1" or less)	A	B	C	D	E	Pcs/Pkg
C 68362	PDBK-90-I	2"	PD-90	2-5/8", 3-1/4"	4-1/2"	5-1/4"	4-7/8"	4-1/8"	1/2"	10
C 68372	PDBK-120-I	2"	PD-120	3-1/4", 4"	5-5/8"	6-3/8"	4-7/8"	5-1/8"	1/2"	5

PDEM

MINI 90° ELBOW



Code No.	Item No.	A	B	Pcs/Pkg
C 68162	PDEM-90-I	4-5/8"	5-3/4"	10
C 68172	PDEM-120-I	4"	5-1/8"	5

PDKS

UNIVERSAL ELBOW

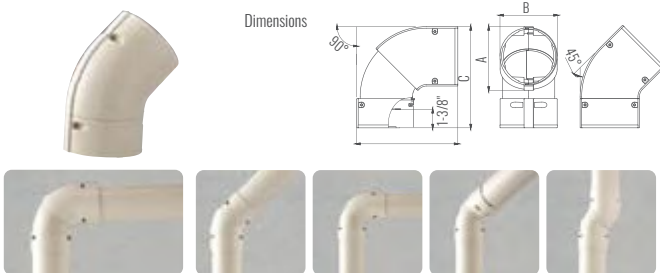

Code No.	Item No.	A	B	C	Pcs/Pkg
C 68282	PDKS-90-I	4-1/8"	4"	7"	10
C 68292	PDKS-120-I	5-1/4"	5-1/8"	8-1/4"	5

PDB-N

MOUNTING COUPLER

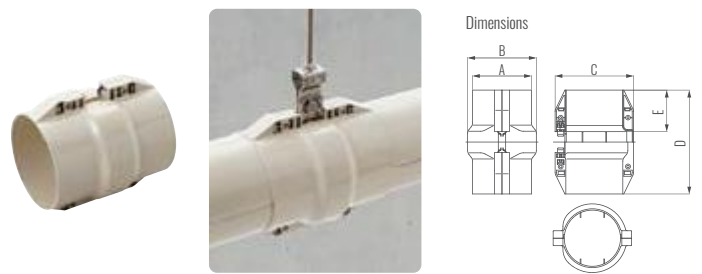

Code No.	Item No.	A	B	C	D	E	Pcs/Pkg
C 68572	PDB-90N-I	4-1/2"	5"	5"	5-1/8"	2"	10
C 68582	PDB-120N-I	5-5/8"	6-1/8"	6-1/8"	5-1/8"	2"	5
C 68692	PDB-140N-I	6-5/8"	7-1/4"	7-1/4"	5-3/8"	2-1/8"	5

PDE

90° ELBOW

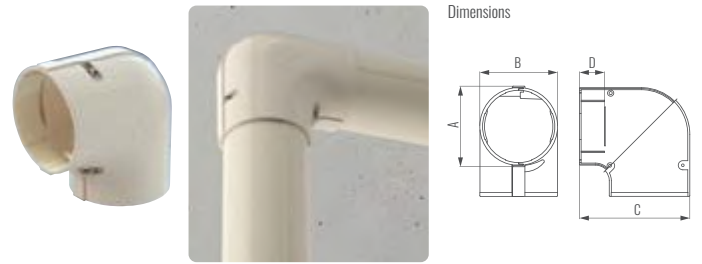

Code No.	Item No.	A	B	C	D	Pcs/Pkg
C 68362	PDE-90-I	4-1/8"	4"	5-5/8"	1-3/8"	10
C 68372	PDE-120-I	5-1/4"	5-1/8"	6-7/8"	1-3/8"	5
C 68642	PDE-140-I	6-1/8"	6"	8"	1-5/8"	5

PDF

45° ELBOW

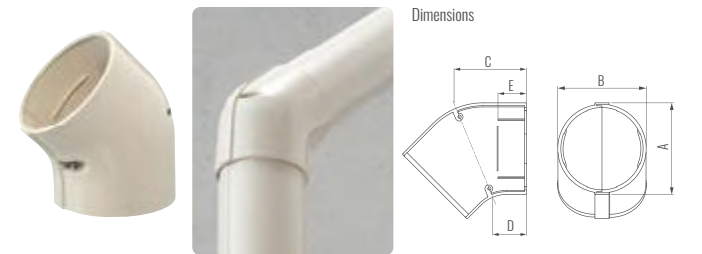

Code No.	Item No.	A	B	C	D	E	Pcs/Pkg
C 68492	PDF-90-I	4-1/8"	4"	3-1/4"	1-1/2"	1-3/8"	10
C 68502	PDF-120-I	5-1/4"	5-1/8"	3-3/4"	1-1/2"	1-3/8"	5
C 68702	PDF-140-I	6-1/8"	6"	4-3/8"	1-7/8"	1-5/8"	5

PDT

TEE



Code No.	Item No.	A	B	C	D	E	F	Pcs/Pkg
C 68402	PDT-90-I	4-1/8"	4"	5-5/8"	4-1/8"	7-1/8"	1-3/8"	10
C 68412	PDT-120N-I	5-1/4"	5-1/8"	6-7/8"	5-1/4"	8-1/2"	1-3/8"	5
C 68662	PDT-140N-I	6-1/8"	6"	8"	6-1/8"	10"	1-5/8"	5

PDTM

MINI TEE

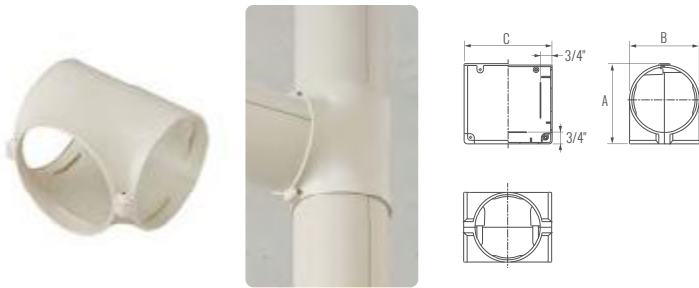

Code No.	Item No.	A	B	C	Pcs/Pkg
C 68182	PDTM-90-I	4-5/8"	4"	5"	10
C 68192	PDTM-120-I	5-3/4"	5-1/8"	6-1/8"	5

PDJ

STANDARD COUPLER



Code No.	Item No.	A	B	C	D	Pcs/Pkg
C 68382	PDJ-90-I	4-1/8"	4"	3-1/4"	1-3/8"	20
C 68392	PDJ-120-I	5-1/4"	5-1/8"	3-1/4"	1-3/8"	10
C 68652	PDJ-140-I	6-1/8"	6"	3-7/8"	1-5/8"	10

PDC

END FITTING



Code No.	Item No.	A	B	C	D	E	Pcs/Pkg
C 68422	PDC-90-I	4-1/8"	4"	2-1/2"	1-7/8"	3-1/4"	20
C 68432	PDC-120-I	5-1/4"	5-1/8"	3-1/2"	2-1/4"	3-1/4"	10
C 68672	PDC-140-I	6-1/8"	6"	3-3/4"	2-3/8"	3-7/8"	10

PDJT

T-BRANCH

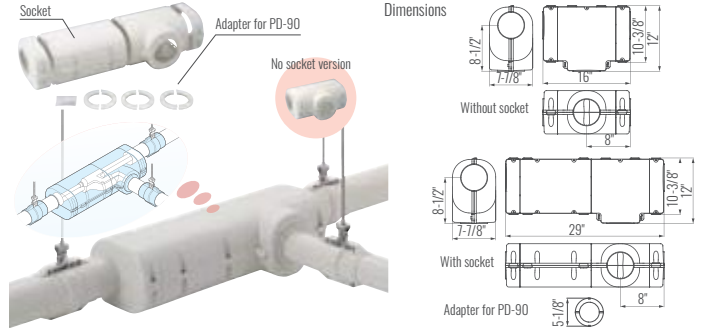

Code No.	Item No.	Pcs/Pkg
C 68552	PDJT-I	1

PWP-N

WALL FLANGE



Code No.	Item No.	A	B	C	D	Pcs/Pkg
C 68522	PWP-90-I	4"	5-3/8"	6-1/4"	12-1/4"	30
C 68532	PWP-120-I	5"	6-1/2"	7-3/8"	15-3/4"	20
C 68682	PWP-140-I	5-7/8"	7-1/4"	8-1/4"	18-5/8"	20

■ Decorative packing is not waterproofing.

PSP

WALL FLANGE FOR FITTINGS



Code No.	Item No.	A	B	C	Pcs/Pkg
C 68592	PSP-90-I	3-1/2"	5-3/8"	6-1/4"	30
C 68602	PSP-120-I	4-5/8"	6-1/2"	7-3/8"	20

■ For connection to fittings except straight PD duct.

PDP

CUTOFF WALL FLANGE

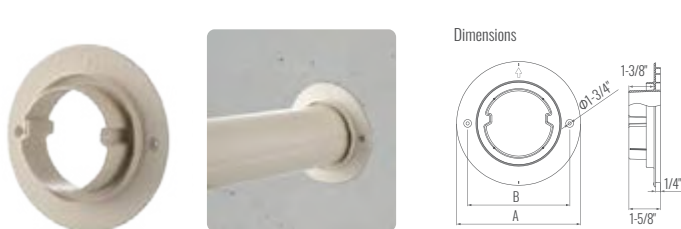

Code No.	Item No.	A	B	C	Pcs/Pkg
C 68882	PDP-90-I	6-1/4"	6-1/4"	5-1/8"	30
C 68892	PDP-120-I	7-3/8"	7-3/8"	6-1/4"	20

PDIC

REDUCER

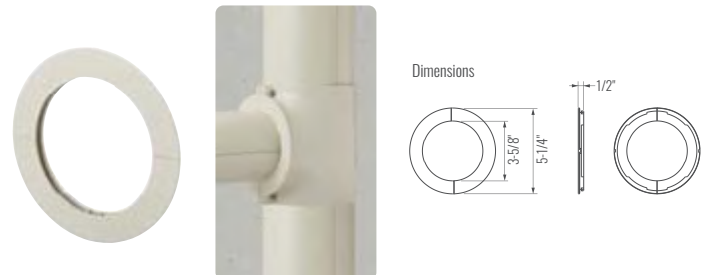

Code No.	Item No.	Pcs/Pkg
C 68202	PDIC-120-90-I	20

PSDR

PD-SD COUPLER



Dimensions

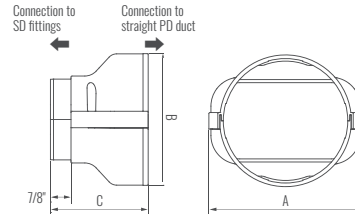

Applicable Connection Parts

Code No.	Item No.	A	B	C	Pcs/Pkg
C 68792	PSDR-90-100-I	4-3/8"	4"	3-5/8"	10
C 68802	PSDR-120-140-I	5-7/8"	5-1/8"	3-3/4"	10

Item No.	SLIMDUCT PD	SLIMDUCT SD
PSDR-90-100-I	PD-90 Duct	Corner fittings for SD-100
PSDR-120-140-I	PD-120 Duct	Corner fittings for SD-140

PDL

FITTING MOUNT CLIP



Dimensions

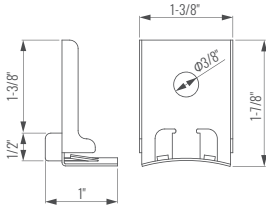

Available to install on the back of connection accessories.

Code No.	Item No.	Pcs/Pkg
C 68480	PDL	200

PDH

FITTING MOUNT CLIP FOR BACK OF CONNECTION ACCESSORIES



Dimensions

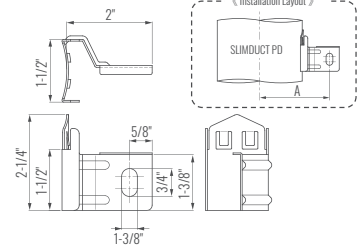

Available to install on the back of connection accessories.

Code No.	Item No.	A	Pcs/Pkg
C 68512	PDH	PD-90	3-1/4"
		PD-120	3-7/8"
		PD-140	4-1/4"

PDTKL

STORAGE COVER



Dimensions

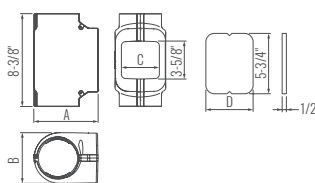

Code No.	Item No.	A	B	C	D	Pcs/Pkg
C 69152	PDTKL-90-I	6"	4-3/4"	3-5/8"	4-1/2"	10
C 69162	PDTKL-120-I	7-1/8"	5-5/8"	4-3/8"	5-1/4"	5

PDY

SUPPORTER BAND

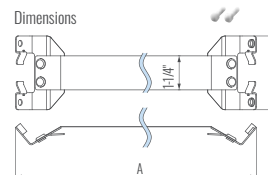

Also can be used for PVC piping band; however, the outer diameter must be smaller than the steel piping.

Code No.	Item No.	Applicable duct	Applicable piping band (For steel pipe*)	A	Pcs/Pkg
C 68612	PDY-90-I	PD-90	2" or less	12-3/8"	30
C 68622	PDY-120-I	PD-120	3-1/4" or less	15-3/4"	30
C 68722	PDY-140-I	PD-140	4" or less	18-5/8"	30

PDK

REINFORCEMENT ACCESSORY FOR NOTCH

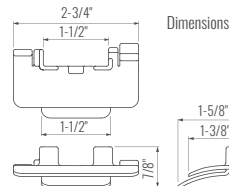

SPECIFICATIONS

- Material ... PP
- Color ... Ivory

FEATURES

- Can be used without PDB-N

- Also can be used for PVC piping band; however, the outer diameter must be smaller than the steel piping.
- Cannot be used for PDY.

Code No.	Item No.	Applicable duct	Applicable piping band (For steel pipe*)	Pcs/Pkg
C 68562	PDK-1	PD-90	2" or less	100
		PD-120	3-1/4" or less	
		PD-140	4" or less	

PDI

REDUCER



Dimensions

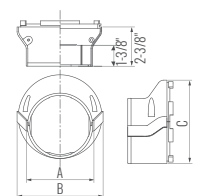

SPECIFICATIONS ■ Connection between PD-90 Duct and PD Parts of 120 size and between PD-120 Duct and PD fittings of 140 size.

Code No.	Item No.	A	B	C	Pcs/Pkg
C 68732	PDI-120-90-I	4-1/8"	5-1/4"	5-1/8"	20
C 68742	PDI-140-120-I	5-1/4"	6-1/8"	6"	20

PDS

PD DUCT SUPPORT BRACKET

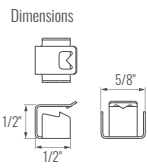

Code No.	Item No.	Pcs/Pkg
C 68210	PDS-90-120 (10 pcs per pack)	40

PDA

PD FITTING CONNECTOR

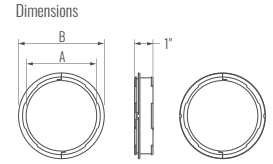
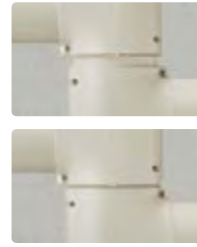

USAGE ■ Adjustable fitting connector for connecting PD fittings each other. (Between 1/8" to 1/2").

Code No.	Item No.	A	B	Pcs/Pkg
C 68082	PDA-90-1	3-1/2"	4-1/4"	20
C 68092	PDA-120-1	4-1/2"	5-1/4"	20

PDU

PD DUCT FIXING SADDLE

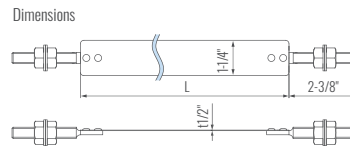

■ In case of vertical piping, fix each parts using such as Fitting Mount Clip PDH, etc.

Code No.	Item No.	Duct Size	L	Pcs/Pkg
C 68762	PDU-90-1	PD-90	8-3/8"	30
C 68772	PDU-120-1	PD-120	11-1/4"	30
C 68782	PDU-140-1	PD-140	13-3/8"	30



SUPERLOCK

Horizontal Lineset support

QUICK and EASY installation by One-Touch clip onto 3/8" threaded rod.



Click here for full product description



Check out our Youtube Playlist

QUICK

Adjustable height

Attaches to 3/8" threaded rod without requiring any tools.

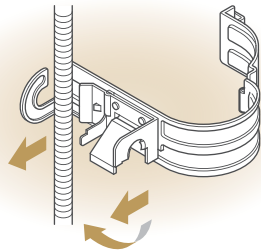

EASY

Adjustable height

A secure fit with a lever for easy height adjustment. May be used in both horizontal or sloped installations.

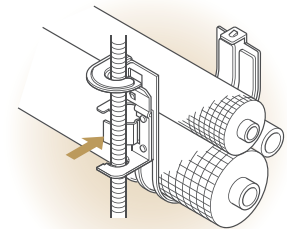

PRACTICAL

Temporary placement of piping

Hinge mechanism allows for piping modifications during installation.

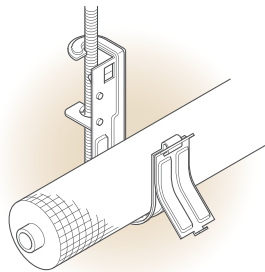

SPACE-SAVING

"Back to Back" Installation

Enables space-saving installations.

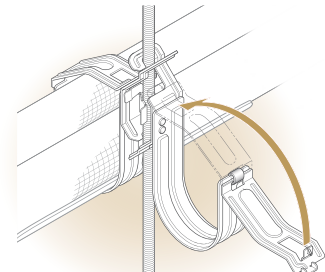

SRV

SUPERLOCK V TYPE



APPLICATION ■ Supports pipe by attaching onto W3/8" threaded rod.

FEATURES ■ SUPERLOCK Clamp quickly snaps onto threaded rod.
 ■ Hinge mechanism permits temporary fixing.
 ■ Easy level adjustment by rotating clamp on threaded rod.

SPECIFICATIONS ■ Steel with SPCC (Unichrome) plating.

CAUTION ■ For indoor use only.
 ■ Use only with W3/8" threaded rod.

INSTALLATION PROCEDURE

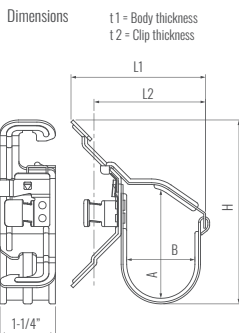
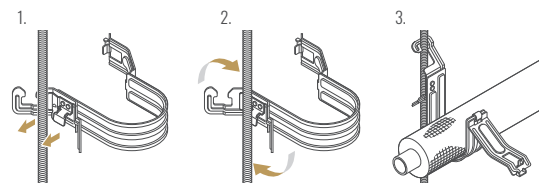

Code No.	Item No.	Allowable static load	Dimensions (inch)					Body thickness (t1)	Body thickness (t2)	Pcs/Pkg
			L1	L2	H	A	B			
C 56220	SRV-24B	169N (44lbs)	2-7/8"	2-3/8"	3-3/4"	2-3/8"	1-1/2"	0.04"	0.04"	100
C 56230	SRV-35B		2-7/8"	2-3/8"	4"	2-3/4"	1-1/2"			100
C 56240	SRV-46B		3"	2-1/2"	4-1/2"	3"	1-5/8"			100
C 56250	SRV-58B		3-3/8"	2-7/8"	4-7/8"	3-3/8"	2-1/8"			100
C 56260	SRV-69B		3-3/8"	2-7/8"	5-1/8"	3-5/8"	2-1/8"			100
C 56270	SRV-710B		3-3/4"	3-1/4"	5-1/8"	3-3/4"	2-1/2"			50
C 56280	SRV-811B		3-3/4"	3-1/4"	5-1/2"	4-1/8"	2-1/2"			50
C 56290	SRV-912B		3-3/4"	3-1/4"	5-3/4"	4-3/8"	2-1/2"			50
C 56295	SRV-1012B		4-1/8"	3-5/8"	6-1/8"	4-3/4"	2-7/8"			50
C 56300	SRV-1114B		4-1/2"	4"	6-3/8"	4-7/8"	3-1/4"			50

SRS

SUPERLOCK S TYPE - Onto 3/8" threaded rod



*The shape of SRS-25, 60 and 65 is different.

Dimensions

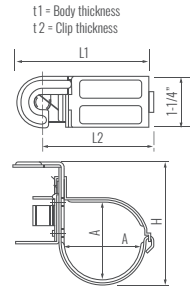

Code No.	Item No.	Allowable static load	Dimensions				Body thickness (t1)	Body thickness (t2)	Pcs/Pkg
			L1	L2	H	A			
C 55890	SRS-25	169N (44lbs)	3"	2-3/8"	3-1/4"	1-3/8"	0.05"	0.04"	100
C 55930	SRS-30		3"	2-1/2"	3-1/4"	1-1/2"			
C 55900	SRS-35		3-1/4"	2-3/4"	3-3/8"	1-3/4"			
C 55910	SRS-40		3-3/8"	2-7/8"	3-3/8"	2"			
C 55940	SRS-45		3-5/8"	3-1/8"	3-1/2"	2-1/8"			
C 55920	SRS-50		3-9/8"	3-3/8"	3-5/8"	2-3/8"	0.06"		
C 55960	SRS-60		4-1/4"	3-3/4"	3-7/8"	2-3/4"			
C 55950	SRS-65		4-3/4"	4-1/4"	5"	3-1/4"			

APPLICATION

- Supports pipe by attaching onto 3/8" threaded rod.

SPECIFICATIONS

- Steel with SPCC (Unichrome) plating.

FEATURES

- SUPERLOCK Clamp quickly snaps onto threaded rod.
- Hinge mechanism permits temporary fixing.
- Easy level adjustment by rotating clamp on threaded rod.

CAUTION

- For indoor use only.
- Use only with 3/8" threaded rod.

OPTIONAL PARTS FOR HANGER SUPPORT

SR-HGZ

INSULATION PROTECTION PLATE for SUPERLOCK

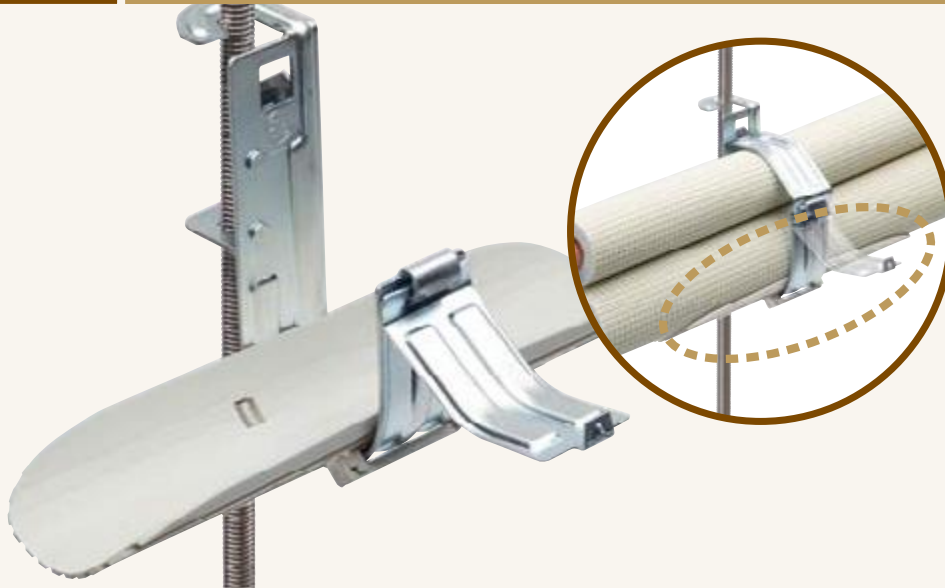

Dimensions

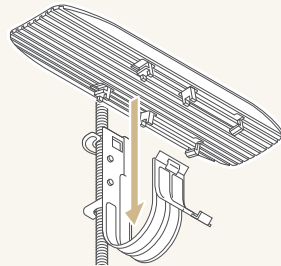
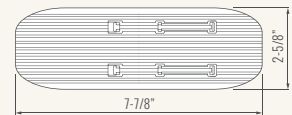

Slide SR-HG to the bottom of SUPERLOCK by passing the hinge part of SUPERLOCK between two nails on the back side of SR-HG.

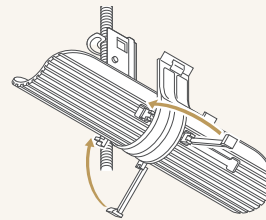

Close lid of SUPERLOCK after installation of piping.

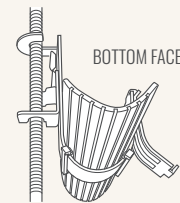

FEATURES

- Protects insulation from deforming.
- Flexible only in the width direction. The plate has ribs at backside and is hard to bend in the length direction.
- Applicable to all sizes of SUPERLOCK (SRV, SRS).
- Easy piping work because the round edge of SR-HG enables pipes to run on it smoothly.

SPECIFICATIONS

- Material: PP
- Color: Ivory

CAUTION

- For indoor use only.

Code No.	Item No.	Pcs/Pkg
C 60780	SR-HGB	200

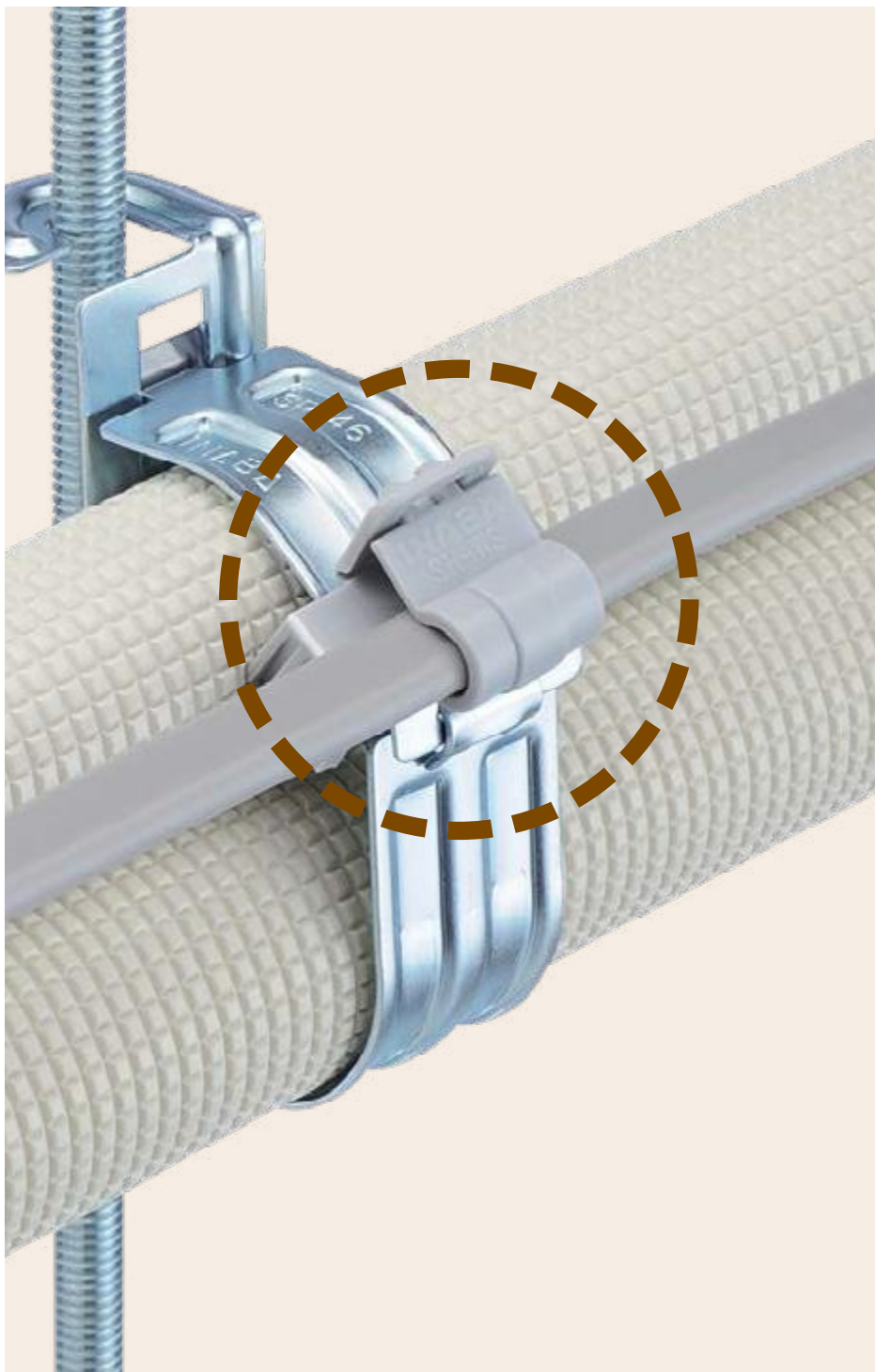

Makes cable installation easier.

One-touch easy lock function prevents falling off.



Eliminates damage of cable insulation.

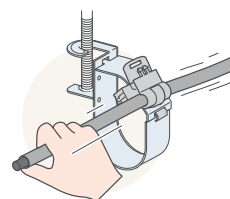

Applicable to both 3/8" threaded rod and SUPERLOCK.

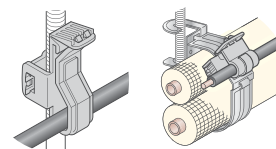

SUPERLOCK with SR-WS

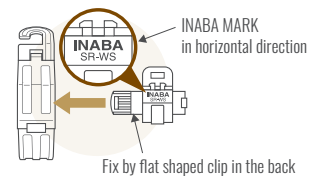

3/8" threaded rod with SR-WS

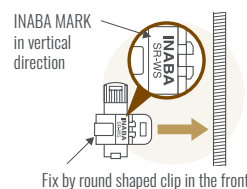

Dimensions

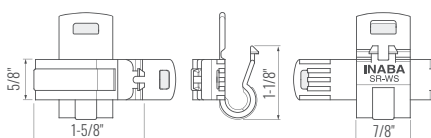

SPECIFICATIONS

- Material: PP
- Color: Gray

CAUTION

- Do not use with round bar
- Always follow local code authority.
- For indoor use only.

Code No.	Item No.	Applicable cable	Applicable	Pcs/Pkg
C 60800	SR-WS	Round cable Ø3/8" Max	SUPERLOCK 3/8" threaded rod	100
		Flat cable 2 cores 0.33" x 0.57" Max. 3 cores 0.30" x 0.67" Max.		

ZC3-W

MAKEUP CAP FOR THREADED ROD

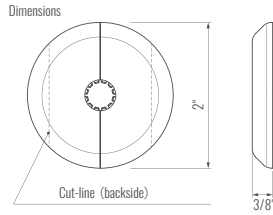

FEATURES

- Cut-line on backside enables to install alongside the wall.

SPECIFICATIONS

- Material: PP
- Color: White

CAUTION

- Use only with 3/8" threaded rod.

Code No.	Item No.	Pcs/Pkg
C 03715	ZC3-W	200

BC3

THREADED ROD MAKE-UP COVER



FEATURES

- Easy to use even on existing installation

SPECIFICATIONS

- Material: EVA
- Color: White and black

Code No.	Item No.	Pcs/Pkg
C 03725	BC3-W	200
C 03724	BC3-K	200

SADDLE

BT

BIGTIE



Dimensions

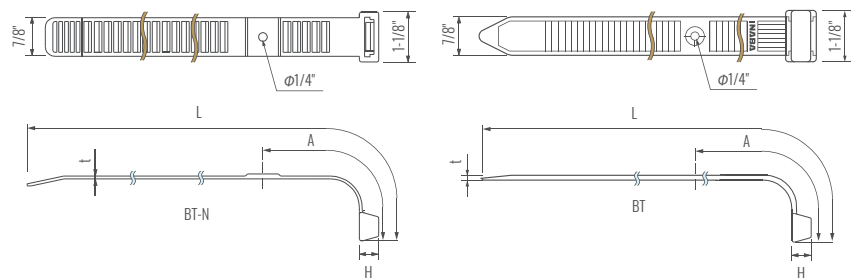

Code No.	Item No.	Binding diameter	L	A	H	t	Pcs/Pkg
C 60330	BT-200N	Ø7/8" - Ø2"	7-7/8"	2"	1/2"	0.06"	40 pcs/pack
C 60340	BT-250N	Ø1-1/4" - Ø2-5/8"	9-7/8"	3-1/4"	1/2"	0.06"	40 pcs/pack
C 60350	BT-300N	Ø1-3/8" - Ø3-1/4"	11-7/8"	3-5/8"	1/2"	0.06"	20 pcs/pack
C 60080	BT-350	Ø1-5/8" - Ø3-7/8"	13-7/8"	4"	1/2"	0.08"	20 pcs/pack
C 60090	BT-400	Ø2" - Ø4-1/2"	15-3/4"	6"	1/2"	0.13"	20 pcs/pack
C 60100	BT-450	Ø2-1/4" - Ø5-1/8"	17-3/4"	6-3/4"	1/2"	0.13"	20 pcs/pack

SPECIFICATIONS

- Material: BT-N: PP BT-PE
- Temperature range (surface temperature) 4°F to 140°F

CAUTION

- BIGTIE is designer for pipe tie. Do not use with loaded condition such as hanger or support for vertical or horizontal piping.

TB-HG

INSULATION PROTECTION PLATE for HANGER



Dimensions

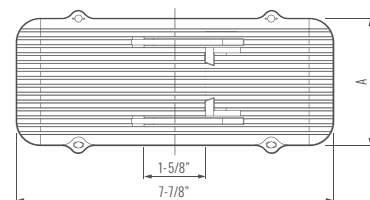

Code No.	Item No.	Size	Pcs/Pkg
C 60790	TB-HG	Regular	200
C 60791	TB-HGL	Large	100

SPECIFICATIONS

- Material: PP
- Color: Ivory

Vertical Lineset support

The "LINEBRACE" clamp supports the weight of vertical lineset risers in VRF/VRV AC systems and reduces the thermal expansion load on the lowest elbow by 50%.

Vertical linesets are always subject to severe stress due to the combination of thermal expansion and gravity, usually resulting in buckling and deformation of the pipe fitting at the lowest extremity.



Click here for full product description

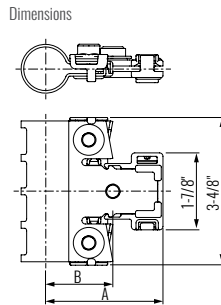

SPECIFICATIONS

- No "hot work" (brazing) required.
- Reduces weight load on vertical riser.
- Reduces thermal expansion by 50%.
- Easy to retrofit onto existing linesets.
- Molded insulation sleeve preserves thermal integrity.
- Available from 3/8" to 1-3/4" in 1/8" increments.
- LineBrace is not suitable for use in refrigeration systems.



Check out our Youtube Video

MATERIAL

- **Clamp:** Type 304 Stainless steel
- **Hex nut & bolts:** M8 Stainless Steel
- **Clamp liner plates:** Polypropylene

Load Capacity

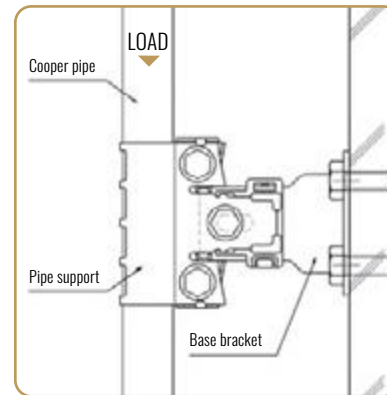

Model	Lbs
TKL-3K	169
TKL-4K	183
TKL-5K	319
TKL-6K	339
TKL-7K	368
TKL-9K	449
TKL-11K	542
TKL-13K	652

■ Maximum load capacities shown under test conditions.

Conventional Installation

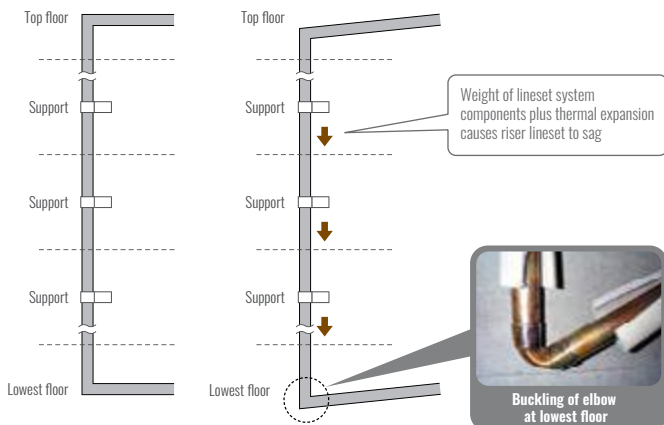

■ Load is transferred to lowest elbow on riser causing it to become compressed and buckled.

Installation with Lineset Support

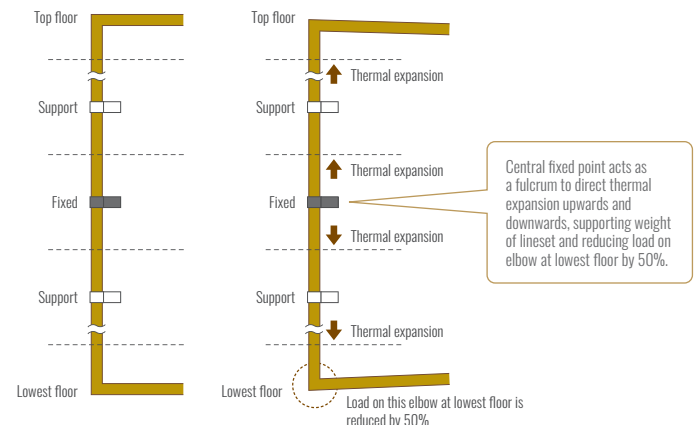

■ For illustration purposes only. When using Lineset Support, provision for thermal expansion is still required.

TKL-H

INSULATION



MATERIAL

■ Polyethylene foam with factor of 30

Code No.	Item No.	Compatible models	Insulation Thickness	A	B	C	D	Pcs/Pkg
C 51603	TKL-3SH	TKL-3K	3/8"	8-3/4"	4-3/4"	3-5/8"	2-1/8"	4
C 51604	TKL-4SH	TKL-4K	3/8"	8-3/4"	4-3/4"	3-5/8"	2-1/8"	4
C 51605	TKL-5SH	TKL-5K	3/8"	8-3/4"	4-3/4"	3-5/8"	2-1/8"	4
C 51606	TKL-6SH	TKL-6K	3/8"	8-3/4"	4-3/4"	3-5/8"	1-3/4"	4
C 51607	TKL-7SH	TKL-7K	3/8"	8-3/4"	4-3/4"	3-5/8"	1-3/4"	4
C 51609	TKL-9SH	TKL-9K	3/8"	8-3/4"	4-3/4"	3-5/8"	1-3/4"	4
C 51611	TKL-11SH	TKL-11K	3/8"	8-3/4"	4-3/4"	3-5/8"	1-3/4"	4
C 51613	TKL-13SH	TKL-13K	3/8"	8-3/4"	4-3/4"	3-5/8"	1-3/4"	4

Code No.	Item No.	Compatible models	Insulation Thickness	A	B	C	D	Pcs/Pkg
C 51703	TKL-3DH	TKL-3K	7/8"	9-1/2"	5-5/8"	3-1/4"	2-7/8"	2
C 51704	TKL-4DH	TKL-4K	7/8"	9-1/2"	5-5/8"	3-1/4"	2-7/8"	2
C 51705	TKL-5DH	TKL-5K	7/8"	9-1/2"	5-5/8"	3-1/4"	2-7/8"	2
C 51706	TKL-6DH	TKL-6K	7/8"	9-1/2"	5-5/8"	3-1/4"	2-5/8"	2
C 51707	TKL-7DH	TKL-7K	7/8"	9-1/2"	5-5/8"	3-1/4"	2-5/8"	2
C 51709	TKL-9DH	TKL-9K	7/8"	9-1/2"	5-5/8"	3-1/4"	2-5/8"	2
C 51711	TKL-11DH	TKL-11K	7/8"	9-1/2"	5-5/8"	3-1/4"	2-5/8"	2
C 51713	TKL-13DH	TKL-13K	7/8"	9-1/2"	5-5/8"	3-1/4"	2-5/8"	2

TKL-B

BASE BRACKET



MATERIAL

■ Hot dip galvanized and powder coated steel

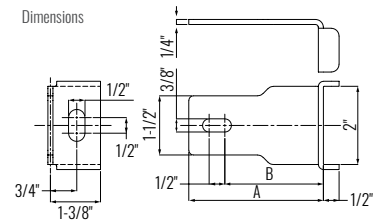

Code No.	Item No.	A	B	Pcs/Pkg
C 51520	TKL-B60	2-5/8"	1-3/4"	100
C 51521	TKL-B70	3"	2-1/8"	100
C 51522	TKL-B80	3-1/2"	2-1/2"	100
C 51523	TKL-B90	3-7/8"	2-7/8"	100
C 51524	TKL-B100	4-1/4"	3-3/8"	100

TKL-U

BASE BRACKET (TOP MOUNTING)

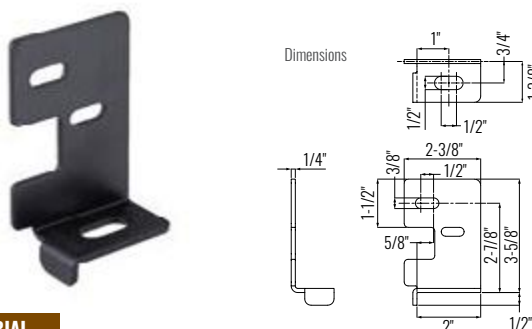

MATERIAL

■ Hot dip galvanized and powder coated steel

Code No.	Item No.	Pcs/Pkg
C 51540	TKL-U00	100

TKL-K

BASE BRACKET (WALL-MOUNTING)

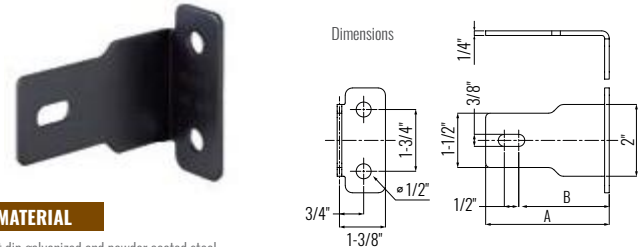

MATERIAL

■ Hot dip galvanized and powder coated steel

Code No.	Item No.	A	B	Pcs/Pkg
C 51530	TKL-K60	2-5/8"	1-3/4"	100
C 51531	TKL-K70	3"	2-1/8"	100
C 51532	TKL-K80	3-1/2"	2-1/2"	100
C 51533	TKL-K90	3-7/8"	2-7/8"	100
C 51534	TKL-K100	4-1/4"	3-3/8"	100

TAPE

JTA

INSULATION JOINT ADHESIVE TAPE

Insulation joint adhesive connects lineset seam eliminating condensation risk.

Outstanding Adhesive Force

Maintains jointing point tightly from thermal shrinkage force.

Tough and Strong

Made of Polyester film.

Tight Grip

Fits perfectly into the embossed insulation surface.

Upgraded workability by easy-peeling release paper.



APPLICATION

- Remove all the dirt and dust from the surface and joint the insulations without any gap.
- When taping, make sure joint part of the insulation comes to the center of the tape.
- Wrap a tape around insulation to pile up on each other at least 1/2" and press it with hands to fit into the (uneven) emboss film.

SPECIFICATIONS

- Material: Aluminum foil + Polyester string contained tape (center part)
- Temperature Range: 14°F to 140°F

Code No.	Item No.	Size (W x L)	Thickness	Color	Pcs/Pkg
C 07396	JTA-100-I	4" x 33'	0.004"	Ivory	12

UVT

UV RESISTANT ADHESIVE TAPE



SPECIFICATIONS

- Material: Polyethylene

Code No.	Item No.	Size (W x L)	Color	Pcs/Pkg
C 07370	UVT-50-I	2" x 65'	Ivory	24
C 07375	UVT-25-I	1" x 65'	Ivory	48

HY

NON-ADHESIVE TAPE - Cling Wrap



FEATURES

- Specially formulated non-adhesive tape will not unroll by itself even if dropped during application.

SPECIFICATIONS

- Material: PVC

Code No.	Item No.	Size (W x L)	Thickness	Color	Pcs/Pkg
C 07052	HY-50-I	2" x 59'	0.005"	Ivory	120
C 07060	HY-50-NI	2" x 59'		New Ivory	120
C 07332	HY-75-I	3" x 59'		Ivory	80
C 07032	HS-50-I	2" x 59'	0.005"	Ivory	120
C 07342	HS-75-I	2" x 59'		Ivory	80

HF

ADHESIVE TAPE STANDARD



SPECIFICATIONS

- Material: PVC

Code No.	Item No.	Size (W x L)	Thickness	Pcs/Pkg
C 13010	HF-0191-B	3/4" x 33'	0.008"	200
C 13020	HF-0191-NI	3/4" x 33'	0.008"	200
C 0711	HF-50	2" x 65'	0.008"	80
C 07120	HF-50-NI	2" x 65'	0.008"	80

HV

ADHESIVE TAPE LIGHT



SPECIFICATIONS

- Material: PVC

C 07082	HV-50-I	2" x 65'	0.007"	80
C 07092	HV-25-I	1" x 65'	0.007"	200

AP

SEALANT PUTTY



1. Open the bag and take out the putty.



2. Knead the putty by hand.



3. Stuff the putty.



FEATURES

- All weather, flame retardant non-drying putty with superior adhesion.
- Temperature range: -4°F to 122°F
- Working temperature: 41°F to 104°F
- *Putty will harden below 41°F, always heat before use at this temperature.

CAUTION

- Oil in putty may stain paint or wallpaper if in direct contact. Use WALL CAP (WC) or A/C CAP (AC) to separate putty from wall surface.

Code No.	Item No.	Color	Contents	Pcs/Pkg
C 0601	AP-200	Gray, Ivory, White	7 oz	100
C 0602	AP-1000		35 oz	20



PAIRCOIL™

Insulated lineset for ductless AC



[Click here for full product description](#)



[Check out our Youtube Video](#)

Paircoil copper tube linesets are designed for efficiency, coming pre-paired and pre-insulated to significantly speed up installation time. Built to meet the highest industry standards, it boasts nine ASTM ratings, including the ASTM E84 (25/50). Made from high-quality annealed copper, Paircoil is easy to flare and flexible enough to bend effortlessly. The insulation is both robust and pliable, offering superior protection against wear and tear over the long term. A2L compatible and available in a range of sizes, Paircoil is the go-to choice for contractors who demand reliability and efficiency.

TECHNICAL SPECS

COPPER TUBE	
ASTM B280 C12200 DHP	Phosphorus Deoxidized Copper Seamless Tube
ASTM B1003	Pressure

INSULATION	
ASTM E84 (25/50)	Surface Burning Characteristics
ASTM C1763	Water Absorption
ASTM E96	Water Vapor Permeability
ASTM C411 & C447	Maximum Use Temperature
ASTM C1427	Linear Shrinkage
ASTM G154	UV Exposure
ASTM C518	Thermal Conductivity

SPECIAL FEATURES

- Labor-saving single-run installation of both lines.
- Embossed film coating allows easier installation.
- Fire retardant cross-linked polyethylene insulation.
- Easily shapes to fit any application.
- R410A compatible.
- A2L refrigerant compatible.



Length markers at every foot for fast, accurate measuring and cutting.

PC

PAIRCOIL



Item No.	Liquid line OD (Inch)	Suction line OD (Inch)	Insulation thickness (Inch)	Length (Feet)	Type
PC-2325-NA	1/4	3/8	1/2	25	Paired
PC-2335-NA	1/4	3/8	1/2	35	Paired
PC-2350-NA	1/4	3/8	1/2	50	Paired
PC-2382-NA	1/4	3/8	1/2	82	Paired
PC-2425-NA	1/4	1/2	1/2	25	Paired
PC-2435-NA	1/4	1/2	1/2	35	Paired
PC-2450-NA	1/4	1/2	1/2	50	Paired
PC-2482-NA	1/4	1/2	1/2	82	Paired
PC-2525-NA	1/4	5/8	1/2	25	Paired
PC-2535-NA	1/4	5/8	1/2	35	Paired
PC-2550-NA	1/4	5/8	1/2	50	Paired
PC-2582-NA	1/4	5/8	1/2	82	Paired
PC-3525-NA	3/8	5/8	1/2	25	Paired
PC-3535-NA	3/8	5/8	1/2	35	Paired
PC-3550-NA	3/8	5/8	1/2	50	Paired
PC-3582-NA	3/8	5/8	1/2	82	Paired
PC-3625-NA	3/8	3/4	1/2	25	Paired
PC-3635-NA	3/8	3/4	1/2	35	Paired
PC-3650-NA	3/8	3/4	1/2	50	Paired
PC-3682-NA	3/8	3/4	1/2	82	Paired



[Click here for full product description](#)



[Check out our Youtube Playlist](#)



Thermal insulated drain-up hose kit for indoor AC units

DSH-UP drain-up hose kit makes it easy to install drain-up piping on indoor commercial AC systems. It eliminates piecing together PVC with multiple adhesive connections, and the risk of water leakage from cement failure. DSH-UP features a flexible insulated drain hose with pre-connected hose fittings that quickly connect to PVC pipes with just a hose band, reducing installation time and the risk of condensation.

✓ REPLACE MULTIPLE ADHESIVE CONNECTIONS

✓ REPLACE RISK OF WATER LEAKAGE

✓ REDUCE LABOR

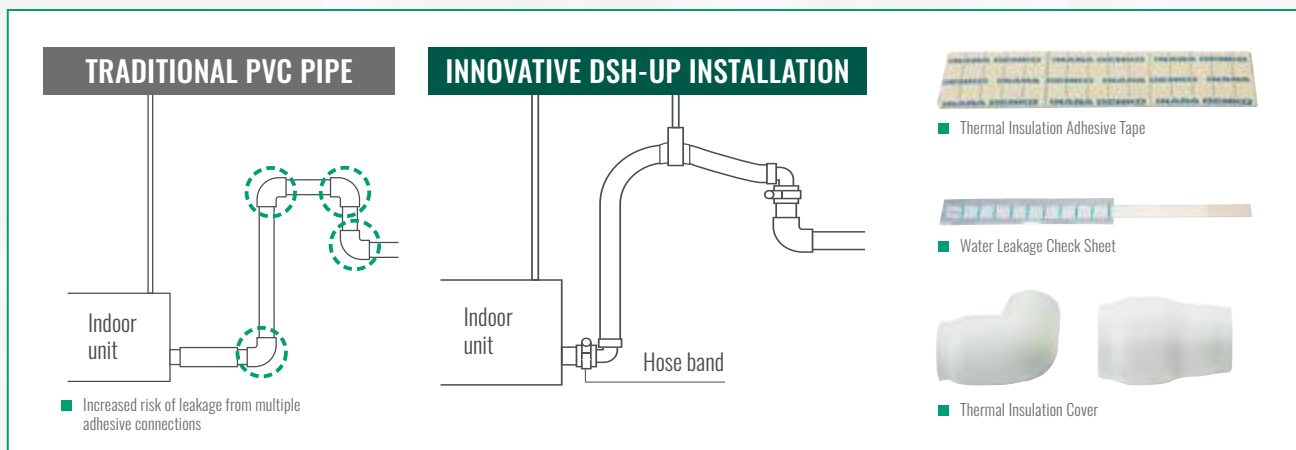

■ Elbow type



■ Straight type

FEATURES

- **Pre-connected hose with fittings.**
- **No cement or adhesives needed.**
Connect fittings to PVC with just a hose band to reduce installation time and avoid the risk of leaking from cement application failures.
- **Pre-insulated hose.**
- **Exclusive insulation technology.**
Decrease on-site insulation work and reduce risks of condensation after insulation.
- **Transparent fittings.**
Connections to PVC pipes are visible to ensure a secure fit.
- **Water leakage check sheet.**
Easily identify leaks when they occur.

S

STRAIGHT TYPE

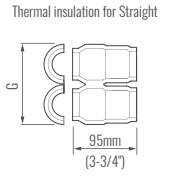
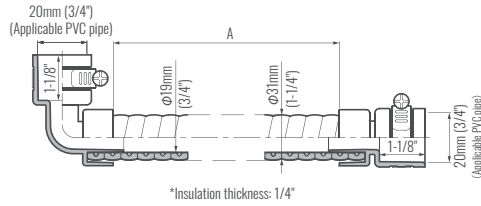
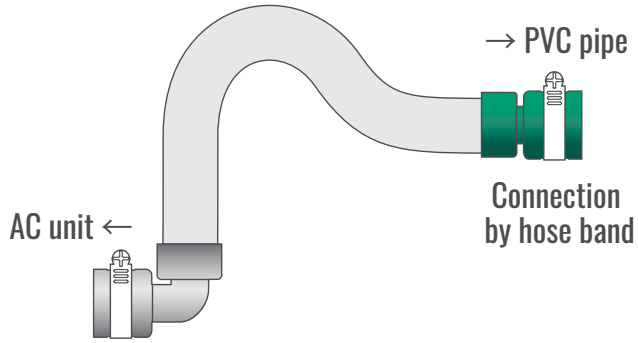

Code No.	Item No.	A	Pcs/Pkg
C 08360	DSH-UP20E20S-07	700mm (27-5/8")	10
C 08370	DSH-UP20E20S-10	1,000mm (39-3/8")	10

E

ELBOW TYPE

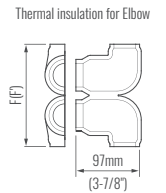
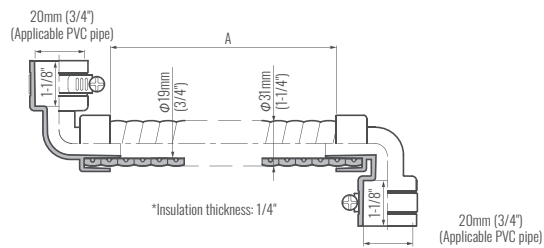
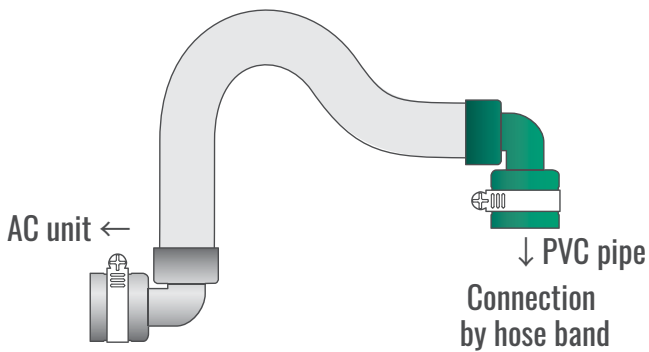

Code No.	Item No.	A	Pcs/Pkg
C 08364	DSH-UP20E20E-07	700mm (27-5/8")	10
C 08374	DSH-UP20E20E-10	1,000mm (39-3/8")	10

ER

ELBOW TYPE

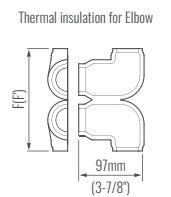
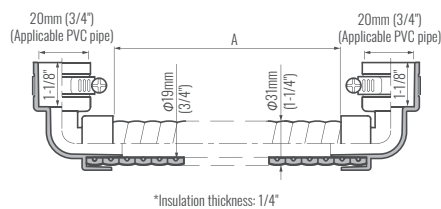
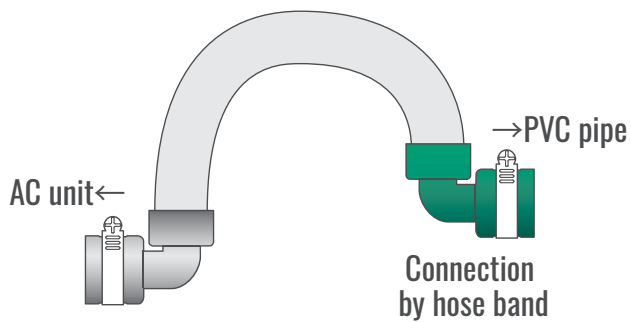

Code No.	Item No.	A	Pcs/Pkg
C 08367	DSH-UP20E20R-07	700mm (27-5/8")	10
C 08377	DSH-UP20E20R-10	1,000mm (39-3/8")	10

KIT DETAILS

	Elbow & Straight S	Elbow & Straight E / ER
Thermal insulated drain hose with coupling joint	1 pc	1 pc
Hose band	2 pcs	2 pcs
Thermal insulation cover - Straight Type	1 pc	-
Thermal insulation cover - Elbow Type	1 pc	2 pcs
Thermal insulation adhesive tape	1 pc	1 pc
Water leakage check sheet	2 pcs	2 pcs

MATERIAL

Thermal insulated drain hose (Outer Layer)	PVC
Thermal insulated drain hose (Inner Layer)	PVC
Thermal insulated drain hose (Middle Layer)	Foamed PE
Coupling joint	PVC
Hose band	SUS
Thermal insulation cover	Foamed PE
Thermal insulation adhesive tape (W2" x L6")	Foamed PE

CAUTION ■ For further information, refer to DSH-UP Installation Manual.

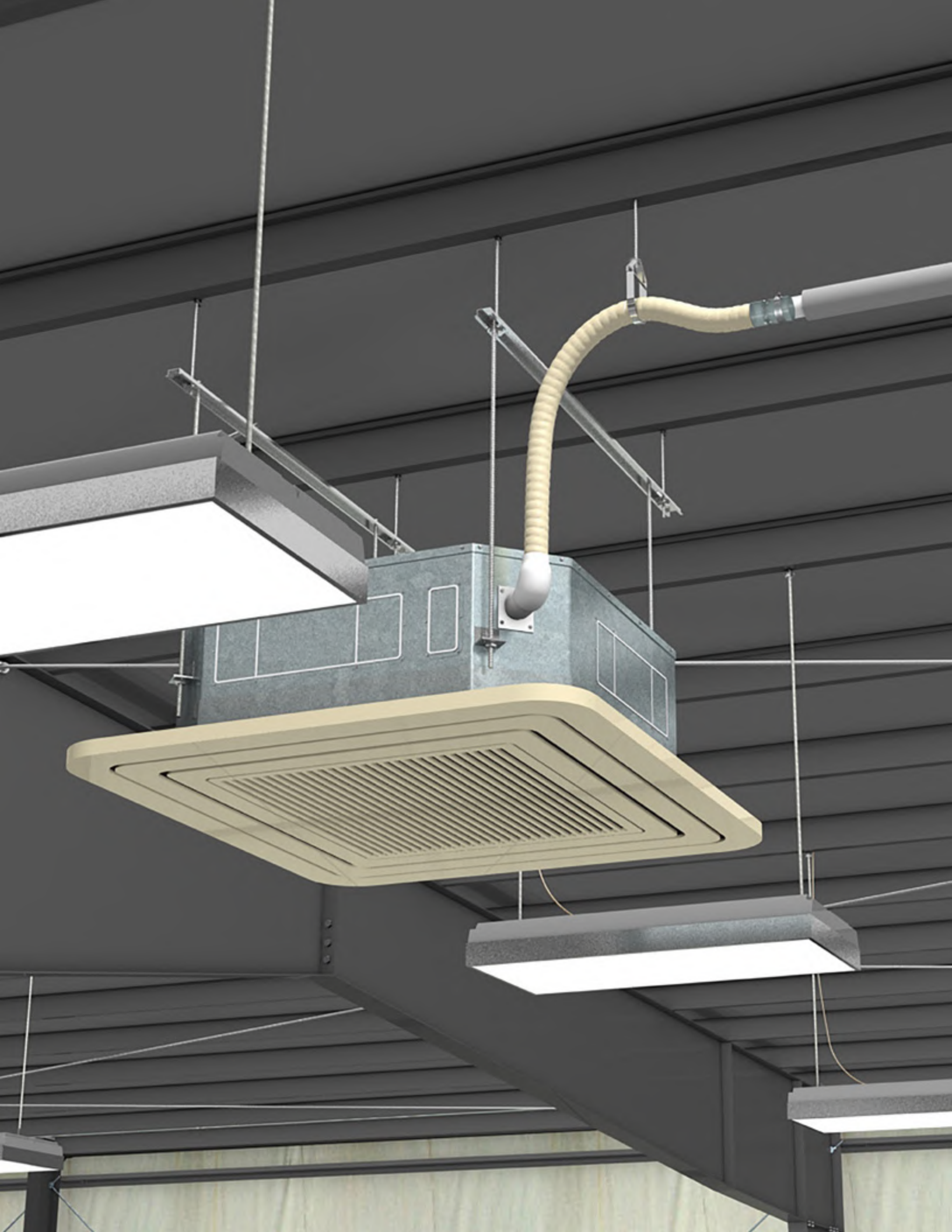

ABOUT US



Inaba Denko America Inc. supplies HVAC accessories engineered by Inaba Denko of Japan and provides support for distributors and contractors throughout North America.

Our brands represent quality, precision, and durability in building materials, with primary products including copper tubes, lineset covers, drain hoses, and mounting systems, ideal for mini split heat pump installations.

Global Philosophy

Inaba Group strives to improve the world by conserving energy and resources and enhancing the comfort of communities and homes.

To expand our reach in North America, we collaborate with partners and customers through Inaba Denko America Inc. We ensure local support and sustain our business for the long term. Furthermore, we utilize our expertise to continuously enhance our products, distribution systems, and customer relationships. Inaba Denko America Inc. helps us connect with partners and customers in North America. Our expertise of over 80 years, aids in improving our products, distribution systems, and relationships with customers.

85 YEAR HISTORY

Our initial business began in 1938 and an HVAC division was established in 1978 as Inaba Denko. Our company has maintained an independent operation and the largest market share in Japan since its founding.

GLOBAL OPERATIONS

Our global network has expanded from Japan to North America, Asia, Oceania, the Middle East, Europe, and Africa over the years. We have seen continued sales achievements worldwide.

DUCTLESS EXPERTISE

We have a wealth of knowledge and expertise in ductless air conditioning to compete in the Japanese market; the birthplace of the ductless system, and to expand globally.

ENSURED QUALITY

Inaba Denko's engineering process in design and development is centralized in Japan and customized at each manufacturing location. Quality is dually controlled by the headquarters and each manufacturing location.

STABILITY & CONTINUITY

We maintain a dispersive manufacturing strategy for stable supply and business continuity. That includes three company factories in Japan and one in Thailand as well as partner factories throughout Asia.

EFFICIENT LOGISTICS

We efficiently manage global logistics through our corporate factories and our partners' warehouses. We utilize the distribution centers of our channel partners in the U.S. for faster delivery.

Foaming seal

INABA DENKO

AMERICA



Inaba Denko America
19750 S. Vermont Ave. Suite 140
Torrance, CA 90502
310-943-7520

www.InabaDenko-America.com